

SW3 DIN

Compact Switch
for Secondary
Substations

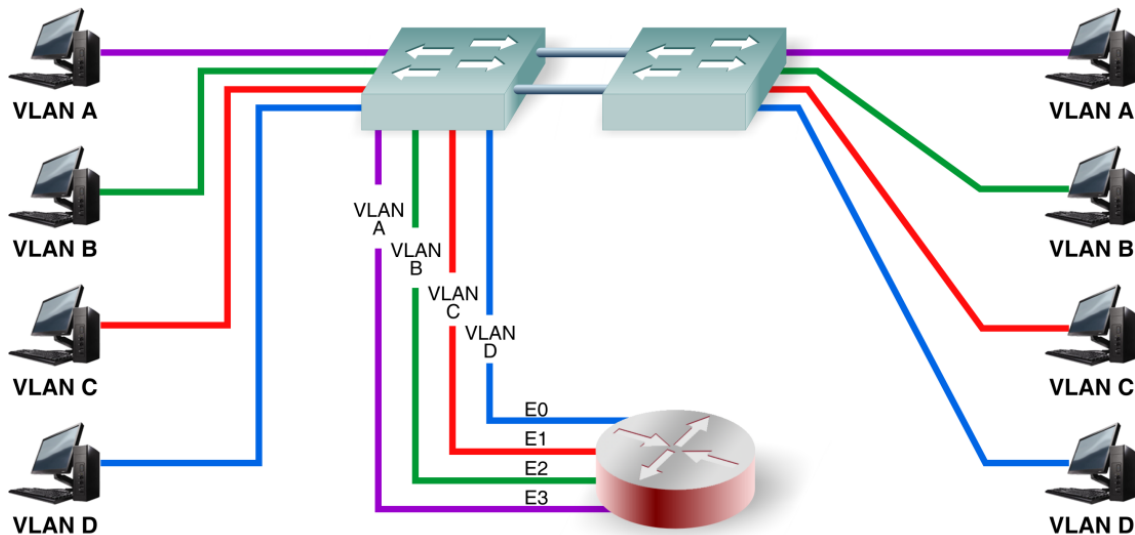

The SW3 is a compact switch that fulfils all the required functions to set up a reliable network within a Secondary Substation.

It also includes the necessary capabilities to implement the automation of Electrical Substations according to IEC 61850 standard.

The SW3 supports **SNMPv1**, **SNMPv2c** and **SNMPv3** management protocols, as well as other protocols and services such as **LLDP**, **GARP/GMRP**, **IGMP**, **NTP/SNTP**, **TACACS+** and **RADIUS**.

The SW3 not only complies with the STP and RSTP protocols for managing loops in the network, but it also improves the recovery times obtained through said protocols.

Main applications

Deployment of big scale LANs when the main requirements are: port density, switching performance, and logical complexity.

Equipment interfaces

- 1 service console (DCE mode).
- 2 front Gigabit Ethernet SFP bays.
- Up to 8 front Fast Ethernet ports (RJ-45 and/or MT-RJ or, upon request, LC or ST).

Main facilities

Full Duplex Wired Speed switching core. Port speed automatic detection. STP and RSTP. Multiple VLANs management (250 simultaneously). QoS. Broadcast and Multicast traffic limitation. MAC access control lists and 802.1x user authentication. Q-in-Q operation (double-tagged). Link aggregation by LAG function (static). Port mirroring. Links in VLAN Native mode. Interoperability with IEDs that complies with IEC 61850.

Management system

- HTTP graphical web-based, SSL.
- SNMP v1, v2c, v3.
- Telnet, VT100, SSH.
- Command Line Interface (CLI).
- RSA Key Management.
- Authentication and Accounting - TACACS+ (encrypted), RADIUS client.
- TLS 1.0

Additional services

- LLDP; GARP/GMRP, IGMP, NTP/SNTP, PVLAN.

Technical Information

Fast Ethernet ports	Up to 8 ports in the following way: <ul style="list-style-type: none"> ➤ 8 ports type 10/100Base-Tx with RJ-45 connector ➤ 4 ports type 10/100Base-Tx with RJ-45 connector and 4 ports type 100Base-Fx MM (1300 nm) with MT-RJ or, upon request, LC or ST connector
Service port	<ul style="list-style-type: none"> ➤ DB9 female connector in DCE mode. Speed of 115200 bit/s
Mounting	<ul style="list-style-type: none"> ➤ DIN-rail mounting ➤ Dimensions: Height: 167 mm; Width: 51 mm; Depth: 116 mm ➤ Weight: 850 g
Power supply	<ul style="list-style-type: none"> ➤ 10.5-72 V_{DC} (48 V_{DC} nominal) or multirange (36-360V_{DC}, 80-265V_{AC}) ➤ Max. consumption at 48 V_{DC}: 12 W ➤ Max. consumption at 230 V_{AC}: 22 W
Temperature range	From -40° C to +85°C
Material	Grey (RAL 7024) zinc-plating iron
Electromagnetic compatibility	Complies with harsh EMC standards

