

TPI

Maximum / Minimum Voltage Protection

Instructions Manual

License agreement for Software Embedded in Equipment

ZIV APLICACIONES Y TECNOLOGIA, S.L. End-User Software License Agreement

THE EQUIPMENT YOU HAVE PURCHASED INCLUDES EMBEDDED SOFTWARE PROGRAM(S). THE PROGRAM IS COPYRIGHTED AND IS BEING LICENSED TO YOU (NOT SOLD) FOR USE WITH THE EQUIPMENT.

THIS IS A LEGAL AGREEMENT BETWEEN US (AS “LICENSEE”) AND ZIV APLICACIONES Y TECNOLOGIA, S.L. (AS “LICENSOR”) FOR THE SOFTWARE PROGRAM INCLUDED WITH THE EQUIPMENT. PLEASE READ THE TERMS AND CONDITIONS OF THIS LICENSE AGREEMENT CAREFULLY BEFORE USING THE EQUIPMENT.

IF YOU INSTALL OR USE THE EQUIPMENT, YOU ARE ACCEPTING AND AGREEING TO THE TERMS OF THIS LICENSE AGREEMENT. IF YOU ARE NOT WILLING TO BE BOUND BY THE TERMS OF THIS LICENSE AGREEMENT, YOU SHOULD PROMPTLY RETURN THE EQUIPMENT UNUSED TO YOUR SELLER, AND YOU WILL RECEIVE A REFUND OF YOUR MONEY.

Terms and Conditions of License

1. **License Grant.** Licensor hereby grants to you, and your accept, a nonexclusive and non-transferable license to use the embedded programs and the accompanying documentation, if any (collectively referred to as the “Software”), only as authorized in this License Agreement.
2. **Restrictions.** You may not (a) use, copy, modify or transfer the Software except as expressly provided in this or another Agreement with Licensor, (b) reverse engineer, decompile or disassemble or separate the components of the Software, or (c) rent, sell or lease the Software or make the Software available to others to do any of the foregoing.
3. **No Assignment.** This License is intended for your exclusive use with the purchased equipment. You agree that you will not assign, sublicense, transfer, pledge, lease, rent or share your rights under this License Agreement.
4. **Licensor’s Rights.** You acknowledge and agree that the Software is the proprietary product of Licensor protected under U.S. copyright law and international treaties.. You further acknowledge and agree that all right, title and interest in and to the Software, including associated intellectual property rights, are and shall remain with Licensor. This License Agreement does not convey to you an ownership interest in or to the Software, but only a limited right of use revocable in accordance with the terms of this License Agreement.
5. **Confidentiality.** The Software is confidential and no details or information relating to the same shall be disclosed to any third party without the prior written consent of Licensor. For the purposes of this clause, sub-contract staff, employed or retained by the Licensee to perform computer systems development work, shall not be deemed to be third parties provided such staff are subject to the disclosure restrictions set forth above. In no event, except with a prior written authorization duly signed by an officer of Licensor, may you disclose any such confidential information, even for subcontracted jobs, to persons or entities that may be considered to be direct competitors of Licensor.

6. **Term.** The License Agreement is effective upon delivery of the equipment to you and shall continue until terminated. You may terminate this License Agreement at any time by returning the equipment to Licensor, or by destroying the equipment. Licensor may terminate this License Agreement upon your breach of any term hereof. Upon such termination by Licensor, you agree to return the equipment to Licensor.
7. **Warranty and Disclaimer.** Licensor warrants, for your benefit only, that the Software, when and as delivered to you, will conform to the specifications described in the instruction manuals for the equipment purchased, or any specifications agreed to in writing by Licensor with a particular customer. This warranty does not cover any minor errors or deviations from the specifications that do not affect the proper functioning of the equipment. **EXCEPT FOR THE WARRANTIES SET FORTH ABOVE, THE SOFTWARE IS LICENSED “AS IS”, AND LICENSOR DISCLAIMS ANY AND ALL OTHER WARRANTIES, WHETHER EXPRESS OR IMPLIED, INCLUDING, WITHOUT LIMITATION, ANY IMPLIED WARRANTIES OF MERCHANTABILITY OR FITNESS FOR A PARTICULAR PURPOSE.**
8. **Licensee’s Remedy.** Your sole and exclusive remedy for any breach of Licensor’s warranty shall be the repair or replacement, at Licensor’s sole option, of any Software that does not conform to stated specifications. Licensor shall not be responsible for any failure arising from inadequate or improper use of the Software.
9. **Limitation of Liability.** Licensor’s cumulative liability to you or any other party for any loss or damages resulting from any claims, demands, or actions arising out of or relating to this Agreement shall not exceed the purchase price paid to Licensor for the equipment. In no event shall Licensor be liable for any indirect, incidental, consequential, special, or exemplary damages or lost profits, even if Licensor has been advised of the possibility of such damages.
10. **Trademark.** All ZIV trademarks (including ZIVERCOM, ZIVERLOG and ZIVERSYS) are common law trademarks of Licensor. No right, license or interest in such trademarks is granted hereunder, and you agree that no such right, license or interest shall be asserted by you with respect to such trademark.
11. **Licensee’s Indemnity.** You shall defend, indemnify and hold Licensor harmless against any loss or damage of any kind arising from a breach by you of this License Agreement, or any use or misuse of the Software by you or your employees, agents or representatives, and from any other of your conduct or from any claim or action by any of your customers in connection with the Software or this License Agreement.
12. **Governing Law.** This License Agreement shall be construed and governed in accordance with the internal laws of the State of Illinois, U.S.A.
13. **No Waiver.** The failure of either party to enforce any rights granted hereunder or to take action against the other party in the event of any breach hereunder shall not be deemed a waiver by that party as to subsequent enforcement of rights or subsequent actions in the event of future breaches.
14. **Entire Agreement.** This License Agreement is the entire agreement between you and Licensor with respect to the use of the software and supersedes all prior understandings or agreements between the parties. This License Agreement may be amended only by a writing signed by an officer of Licensor.

ZIV Aplicaciones y Tecnología, S.L.
Parque Tecnológico, 2089
48016 Zamudio (Vizcaya)
48080 Bilbao
Spain

Table of Contents



Chapter 1. Description		
1.1	Functions	1-2
1.2	Additional Functions	1-3
1.3	Model Selection	1-4
Chapter 2. Technical Data		
2.1	Power Supply Voltage	2-2
2.2	Power Supply Burden	2-2
2.3	Voltage Inputs	2-2
2.4	Measurement Accuracy	2-2
2.5	Repeatability	2-2
2.6	Digital Inputs	2-3
2.7	Trip Outputs	2-3
2.8	Auxiliary Outputs	2-3
2.9	Communications Link	2-4
Chapter 3. Standards and Type Tests		
3.1	Insulation	3-2
3.2	Electromagnetic Compatibility	3-2
3.3	Environmental Test	3-3
3.4	Power Supply	3-3
3.5	Mechanical Test	3-3
Chapter 4. Physical Architecture		
4.1	General	4-2
4.2	Dimensions	4-3
4.3	Connection Elements	4-4
4.3.1	Terminal Connectors	4-4
4.3.2	Removing Printed Circuit Boards (Non Self-Shorting)	4-4
4.3.3	Internal Wiring	4-4
Chapter 5. Settings		
5.1	Configuration Settings	5-2
5.2	General Settings	5-3
5.3	Voltage Protection Settings	5-3
5.4	Logic Settings	5-5
5.5	Status Contact Inputs, Auxiliary Contact Outputs and LED Targets	5-6
Chapter 6. Description of Operation		
6.1	Voltage Elements	6-2
6.1.1	Open-Delta Voltage Element (TPI-E)	6-3
6.1.2	Maximum-Voltage Elements	6-4
6.1.3	Minimum-Voltage Elements	6-4
6.1.4	Blocking the Elements	6-4
6.1.5	Voltage/Time Characteristic	6-5
6.2	General Settings	6-7
6.3	Logic (Trip Masking)	6-7
6.4	Event Recording	6-8



6.5	Contacts Inputs, Outputs and LEDs	6-10
6.5.1	Status Contact Inputs.....	6-10
6.5.2	Auxiliary and Trip Contact Outputs	6-11
6.5.3	LEDs	6-13
6.6	Communications	6-14
6.6.1	Communications Settings	6-14
6.6.2	Communications Types	6-14
6.6.3	Communicating with the Unit	6-14
Chapter 7. Alphanumeric Keypad and Display		
7.1	Alphanumeric Display and Keypad	7-2
7.2	Keys, Functions and Operation Modes.....	7-3
7.3	Screens Sequence Using a Single Key	7-4
7.4	Display Sequence Using the Complete Keypad	7-6
Chapter 8. Receiving Tests		
8.1	General	8-2
8.1.1	Accuracy	8-2
8.2	Preliminary Inspection.....	8-3
8.3	Insulation Test.....	8-3
8.4	Voltage Measuring Test.....	8-4
8.5	Overvoltage/Undervoltage Units Test.....	8-5
8.6	Operating Time Test	8-6
8.7	Contact Inputs, Auxiliary Outputs, and LED Targets Test	8-7
8.8	Communications Test	8-8
8.9	Installation	8-8
8.9.1	Location.....	8-8
8.9.2	Connection	8-8
Annex A. DNP 3.0 Communications Protocol		
A.1	Physical Architecture	A-2
A.2	Settings	A-3
A.3	Description of Operation	A-3
A.3.1	DNP 3.0 Protocol	A-3
A.3.2	Communications	A-4
A.4	Alphanumeric Keypad and Display.....	A-4
A.4.1	DNP 3.0 Settings Menu (ZIVERcom®).....	A-4
Annex B. Schemes and Drawings		
Annex C. List of Illustrations and Tables		
C.1	Lista de figuras.....	C-2
C.2	Lista de tables.....	C-2
Annex D. Warranty		

1. Description



1.1	Functions	1-2
1.2	Additional Functions.....	1-3
1.3	Model Selection	1-4



TPI units, designed with digital technology, are part of a family of digital systems that provide protection against maximum and/or minimum voltage as well as metering and communication functions.

TPI systems are suitable for all those installations needing reliable detection of voltage changes.

1.1 Functions

- **Single-phase Voltage Protection (1x27 and/or 1x59). Model TPI-A**

It has one voltage measurement analog input with two associated protection units, each with its respective independent settings. Each of these units can be configured to function as an overvoltage or undervoltage unit.

Each voltage protection element is made up of an instantaneous element, with an additional programmable delay and a delayed or inverse curve time element. There are settings for enabling or disabling each of these elements.

It should be kept in mind that the special model **TPI-A**-***12**** does not support time curves, just definite time (DT).

- **Three-phase Voltage Protection (3x27 and/or 3x59). Model TPI-B**

It has three voltage measurement analog inputs. All these inputs are associated to two protection units, each of which has independent settings. Each of the units can be set to function as an overvoltage or an undervoltage unit.

Each voltage protection element is made up of an instantaneous element with an additional programmable delay and a definite or inverse curve time element. There are settings for enabling or disabling each of the elements.

- **Single-phase Residual Voltage Protection (1x59N). Model TPI-C**

The **TPI-C** model has an analog input for measuring maximum residual voltage made up of a user-configurable definite time element. The delayed time protection can be converted to instantaneous by setting the definite time to zero. There are also settings for enabling or disabling this time element.

The special model **TPI-C**-***10*** has three analog inputs through which the maximum ground voltage (VG) calculation is made.



- **Voltage Protection [(3x27 and/or 3x59) + (1x59N)]. Model TPI-E**

It has three voltage measurement analog inputs for the phases. The open delta is calculated internally. The phases have two associated protection units with their corresponding independent settings. Each unit can be set to function as an overvoltage or an undervoltage unit. In addition, there is a neutral overvoltage protection unit (open delta).

Each phase voltage protection element is made up of an instantaneous element with an additional programmable delay and a definite or inverse curve time element. The open-delta unit is made up of only one instantaneous element with an additional programmable delay. There are settings for enabling or disabling each of the elements.

It should be kept in mind that the special model **TPI-A**-***12**** does not support time curves, just definite time (DT).

1.2 Additional Functions

- **LEDs Targets**

There are eight LED targets, seven of which are configurable while the eighth indicates "Ready". The list of available signals that can be assigned to the LED targets is provided in Chapter 6.

- **Status Contact Inputs**

The unit has two configurable status contact inputs. Chapter 6 indicates the inputs available for the unit.

- **Auxiliary Contact Outputs**

There are three configurable auxiliary contact outputs (two of which can be configured through communications). Two of these outputs (AUX-2 and AUX-3) correspond to NO or NC Form C contacts, while the contacts for AUX-1 can be set to NO and/or NC by means of their internal jumpers. Chapter 6 indicates the auxiliary contact outputs available for the unit.

- **Local Information (display)**

The units have an alphanumeric *display* for viewing information about operations and metering:

- Operations:
 - Last trip (unit and date)
 - Contact input status
 - Contact output status
- Metering:
 - Voltages

- **Self-test Program**

The unit has a self-test program that verifies the proper operation of all the components of the system.



1.3 Model Selection

	TPI		0	B							
1	2	3	4	5	6	7	8	9			
1	Selection		3 Vertical Format				8 Horizontal Format				
2	Functions		A Single-phase (1x27) / (1x59) (*)				C Residual Voltage Single-phase (1x59N) (*)				
			B Three-phase (3x27) / (3x59) (*)				E (3x27 / 3x59) + (1x59N) (*)				
3	Power Supply		Digital Inputs		Power Supply		Digital Inputs				
	1	24 - 48 Vdc (**)	24 - 48 Vdc		3	220 - 250 Vdc (**)	48 - 250 Vdc				
	2	110 - 125 Vdc (**)	24 - 125 Vdc		4	230 Vca (**)	230 Vdc				
4	Rated Voltage / Frequency / Language		1 110 and 110/3V, 50Hz, Spanish				D 120 and 120/3V, 60Hz, Spanish				
	3	120 and 120/3V, 60Hz, English					F 120 and 120/3V, 60Hz, Portuguese				
	B	110 and 110/3V, 50Hz, English					K 110 and 110/3V, 50Hz, Portuguese				
5	Communications		1 RS232 + without Remote Communications				4 RS232 + Glass F.O. (conn. ST)				
	2	RS232 + Plastic F.O. (1 mm.)					5 RS232 + RS485				
	3	RS232 + Glass F.O. (conn. SMA)									
6	0	Standard					1 RS232 Remote***				
7	Special Models		00 Standard Model				11 Temporization: 0.1 - 300 s.				
	10	Single-phase with 3 transf. (only TPI-C)					12 Hysteresis <5%. Without time elements. Only Definite Time (DT).				
8	Type of Enclosure		D 6 x 1/7 19" rack				V 19" rack, 6U				
9	Communications Protocols		A Protec. No Procome + without Ctrl.				F Protec. No Procome + Ctrl. Modbus and Procome				
	E	Protec. No Procome + Ctrl. DNP3 and Procome					G Spare				

* Selectable in the unit

** ±20

*** Only if Communications = 1

• Functions

27	Undervoltage Protection.
59	Overvoltage Protection.
59N	Ground Overvoltage Protection.

2. Technical Data



2.1	Power Supply Voltage	2-2
2.2	Power Supply Burden	2-2
2.3	Voltage Inputs	2-2
2.4	Measurement Accuracy	2-2
2.5	Repeatability	2-2
2.6	Digital Inputs	2-3
2.7	Trip Outputs	2-3
2.8	Auxiliary Outputs.....	2-3
2.9	Communications Link.....	2-4



2.1 Power Supply Voltage

Selectable range depending on model:

24 - 48Vdc ($\pm 20\%$)
 110 -125Vdc ($\pm 20\%$)
 220 - 250Vdc ($\pm 20\%$)
 230 Vac ($\pm 20\%$)

Note: In case of power supply failure, a maximum interruption of 100 ms is allowed for 110 Vdc input.

2.2 Power Supply Burden

Quiescent	7 W
Maximum	11 W

2.3 Voltage Inputs

Rated Value	Vn = 110 V (50 Hz)
Thermal Withstand Capability	2Vn (continuously)
Voltage Circuit Burden	Vn = 110V < 0.5VA

2.4 Measurement Accuracy

Measured voltages	
Internal measure accuracy	< 5 %
Display measure accuracy	< 5 % $\pm 1V$
Measuring times	
Definite and Inverse Time characteristic (UNE 21-136 and IEC 255)	<5 % or <25ms (the greater)

2.5 Repeatability

Operating time	2 % or 25 ms (the greater)
----------------	----------------------------



2.6 Digital Inputs

Two electrically separate, user-programmable status contact inputs

Digital Input Voltage Range	24 - 125 Vdc ($\pm 20\%$)
(selectable range depending on the model)	48 - 250 Vdc ($\pm 20\%$)
	230 Vac
Current Drain	<5 mA

2.7 Trip Outputs

Two trip contacts internally configurable as NO or NC

I DC maximum limit (with resistive load)	30 A for 1 s
I DC continuous service (with resistive load)	8 A
Close	2500 W
Breaking capability (with resistive load)	150 W - max. 8 A - (48 Vdc)
	55 W (80 Vdc - 250 Vdc)
	1250 VA
Break (L/R = 0.04 s)	60 W at 125 Vdc
Switching voltage	250 Vdc
Momentary close time trip contacts remain closed	100 ms

2.8 Auxiliary Outputs

3 electrically separated contact outputs: 2 NO or NC electrically separated contacts and 1 internally configurable as NO and/or NC

I DC maximum limit (with resistive load)	5 A for 30 s
I DC continuous service (with resistive load)	3 A
Close	2000 W
Breaking capability (with resistive load)	75 W - max. 3 A - (48 Vdc)
	40 W (80 Vdc - 250 Vdc)
	1000 VA
Break (L/R = 0.04 s)	20 W at 125 Vdc
Switching voltage	250 Vdc



2.9 Communications Link

Glass Fiber Optics	
Type	Multimode
Wavelength	820 nm
Connector	ST
Transmitter Minimum Power	
50/125 fiber	- 20 dBm
62.5/125 fiber	- 17 dBm
100/140 fiber	- 7 dBm
Receiver Sensitivity	- 25.4 dBm

Plastic Fiber Optics (1 mm)	
Wavelength	660 nm
Transmitter Minimum Power	- 16 dBm
Receiver Sensitivity	- 39 dBm

RS232C Port Signals	
Connector dB-9 (9 pin) signals used	Pin 5 - GND Pin 2 - RXD Pin 3 - TXD

RS485C Port Signals	
Signals used	A (B5) B (B6)

3. Standards and Type Tests



3.1	Insulation.....	3-2
3.2	Electromagnetic Compatibility	3-2
3.3	Environmental Test.....	3-3
3.4	Power Supply.....	3-3
3.5	Mechanical Test.....	3-3



3.1 Insulation

Insulation Test (Dielectric Strength)	<i>IEC-60255-5</i>
Between all circuit terminals and ground:	2 kV, 50 Hz , for 1 minute
Between all circuit terminals:	2 kV, 50 Hz , for 1 minute
Voltage Impulse Test	<i>IEC-60255-5 (UNE 21-136-83/5)</i>
	5 kV; 1.2/50 μs; 0.5 J

3.2 Electromagnetic Compatibility

1 MHz Burst Test	<i>IEC-60255-22-1 Class III</i> <i>(UNE 21-136-92/22-1)</i>
Common Mode:	2.5 kV
Differential Mode:	1.0 kV
Fast Transient Disturbance Test	<i>IEC-60255-22-4 Class IV</i> <i>(UNE 21-136-92/22-4)</i> <i>(IEC 1000-4-4)</i>
	4 kV \pm10 %
Radiated Electromagnetic Field Disturbance	<i>IEC-61000-4-3</i>
Amplitude modulated (<i>EN 50140</i>)	10 V/m
Pulse modulated (<i>EN 50204</i>)	10 V/m
Conducted Electromagnetic Field Disturbance	<i>EN 50141</i>
Amplitude modulated	10 V
Electrostatic Discharge	<i>IEC-60255-22-2 Class III</i> <i>(UNE 21-136-92/22-2) (IEC 1000-4-2)</i>
	\pm8 kV \pm10 %

Radio Frequency Emissivity	<i>EN 55011 (IEC-61000-4-6)</i>
-----------------------------------	---------------------------------



3.3 Environmental Test

Temperature	<i>IEC-60255-6</i>
Operating range:	From -10 °C to +55 °C
Storage range:	From -25 °C to +70 °C
Humidity:	95 % (non-condensing)

3.4 Power Supply

Power Supply Ripple	<i>IEC-60255-11 / UNE 21-136-83 (11)</i> < 20 %
----------------------------	--

3.5 Mechanical Test

Vibration Test (sinusoidal)	<i>IEC-60255-21-1 Class I</i>
Shock and Bump Test	<i>IEC-60255-21-2 Class I</i>

Models comply with the Directive 89/336/EEC of electromagnetic compatibility



4. Physical Architecture



4.1	General	4-2
4.2	Dimensions	4-3
4.3	Connection Elements.....	4-4
4.3.1	Terminal Connectors.....	4-4
4.3.2	Removing Printed Circuit Boards (Non Self-Shorting).....	4-4
4.3.3	Internal Wiring.....	4-4



4.1 General

TPI protection terminals consist of a circuit board with the following functions:

- Power Supply
- Central Processing Unit
- Analog Inputs
- Contact Inputs and Outputs

Depending on the terminal settings, all the contact inputs / outputs may be used or remain as spare signals.

The external appearance of the unit seen from the front is represented in figure 4.1 for **3TPI** and in figure 4.2 for **8TPI**.

Keypad, alphanumeric display and local communications port are located on the front panel.

The rear panel contains terminal connectors as shown in figures 4.3 (**8TPI** models) and 4.4 (**3TPI** models). Of the two connectors indicated, one corresponds to the transformer secondary analog inputs and the one located at the bottom (on the left in the **8TPI** models) is used for the power supply input and contact inputs and outputs (20 terminal connectors all together).

The transformer secondary connector can be either of two types depending on the **TPI** model. If it has more than two analog inputs, the connector is the one shown in figures 4.3.b and 4.4.b, capable of receiving up to five analog inputs (10 terminal connectors). If the model only has two analog inputs, a 5-terminal connector is used, as shown in figures 4.3.a and 4.4.a.

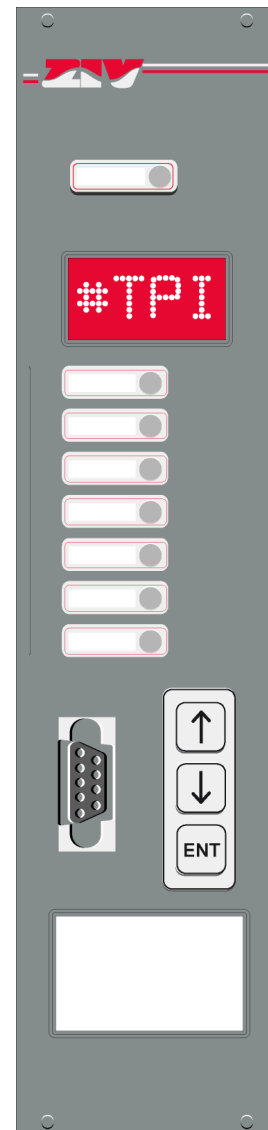

Figure 4.1: 3TPI Front View.

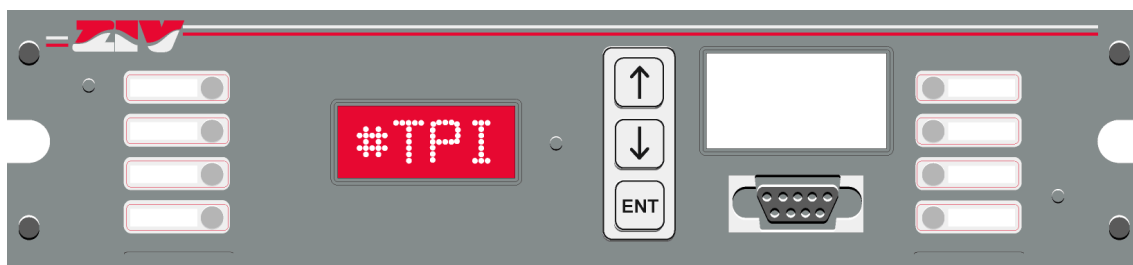

Figure 4.2: 8TPI Front View.

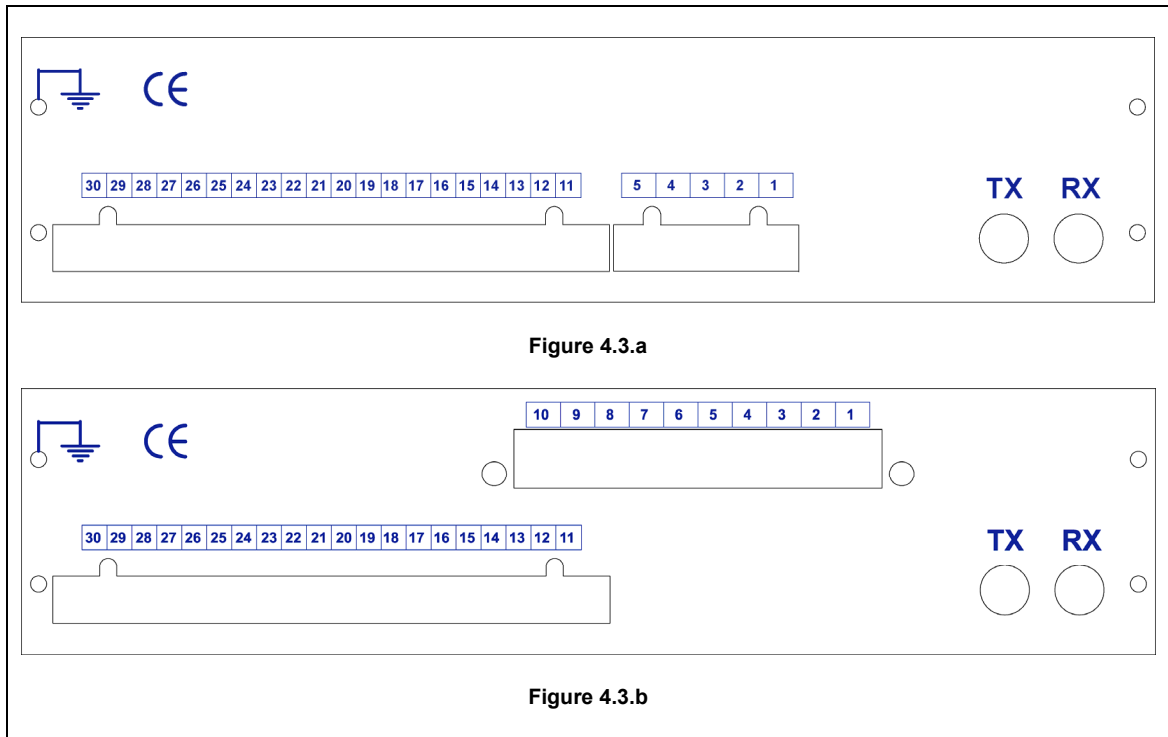

Figure 4.3: 8TPI Rear View.

4.2 Dimensions

Depending on the model, the units are mounted as follows: **3TPI** models in cases that are 1/7 of a 19" rack wide and 6 standard units high (10½") or in a 19"-rack case (constituting part of a system together with other protections); **8TPI** models in a 19"-rack case and 2 standard units high. The equipment is intended to be installed either semi-flush mounted on panels or inside a 19" rack. They are equipped with a transparent cover which can be sealed for security purposes.

Note: 8TPI models are designed to be mounted on a 1-rack wide x 2U high adapter element. A dimension and drilling drawing is provided in Annex B of this manual.



4.3 Connection Elements

4.3.1 Terminal Connectors

The terminal connectors are positioned vertically in **3TPI** models and horizontally in **8TPI** models and have the following number of terminal connectors per column: 1 terminal connector of 5 voltage transformer secondary inputs (10 terminal connectors) or of two voltage transformer secondary inputs (5 terminal connectors) plus another terminal connector of contact inputs and outputs with 20 terminals (see figures 4.3.a and 4.3.b).

The current and voltage analog input terminals accept wire up to 2.5 mm² (4 mm² max.). The remaining circuit terminals permit wire up to 2.5 mm². The unit has communications connectors on the front panel as well as on the back.

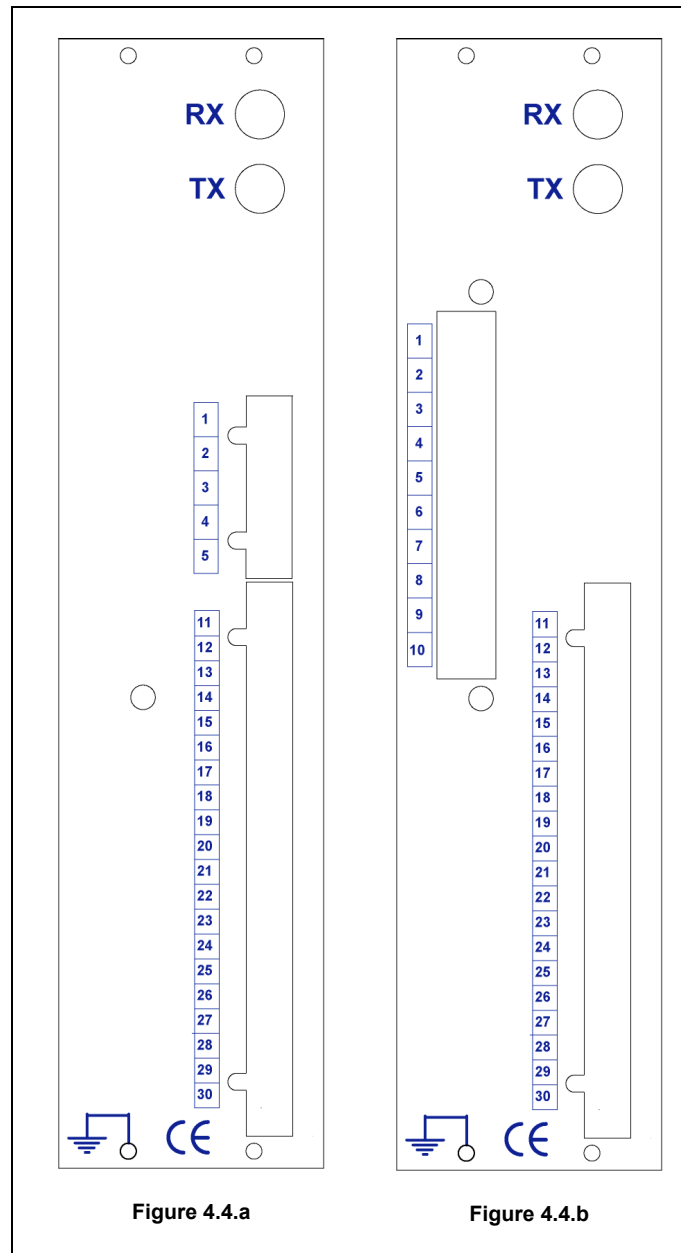

Figure 4.4: 3TPI Rear View.

4.3.2 Removing Printed Circuit Boards (Non Self-Shorting)

The printed circuit board is attached to the case with self-tapping screws. These screws must be removed before the board is withdrawn. It is also necessary to remove the screws from the terminal connectors. This operation always requires the protection to be "not in service".

4.3.3 Internal Wiring

The equipment uses traditional printed circuit board connections and internal buses to minimize internal wiring.

5. Settings



5.1	Configuration Settings.....	5-2
5.2	General Settings	5-3
5.3	Voltage Protection Settings	5-3
5.4	Logic Settings	5-5
5.5	Status Contact Inputs, Auxiliary Contact Outputs and LED Targets	5-6



5.1 Configuration Settings

Communications (HMI). Models TPI-A/B/C	
Setting	Range
Terminal address	0 to 254
Baud rate	300 to 19200 Bauds
Stop bits	1 or 2
Parity	1 (Even) / 0 (No parity)

Communications (RS232 Local Port). Models TPI-E	
Setting	Range
Terminal address	All
Baud rate	4800 Bauds
Stop bits	1
Frontal Port Parity (affects to local port)	1 or 2 (default: 1)

Communications (RS232 Remote Port)	
Setting	Range
Terminal address	0 to 254
Baud rate	300 to 19200 Bauds
Stop bits	1 or 2
Parity	1 (Even) / 0 (No parity)
Timeout (affects to local and remote port)	0 to 100 ms
MODBUS Protocol ⁽¹⁾	YES/NO ⁽²⁾

(1) According to software version.

(2) With NO setting, answers PROCOME Protocol.

Date and Time
Adjustable through communications

Language	
Setting	Range
Language ⁽¹⁾	Spanish English Portuguese

(1) According to software version.

Frequency	
Setting	Range
Frequency ⁽¹⁾	50 Hz / 60 Hz

(1) According to software version.



5.2 General Settings

General Settings		
Setting	Range	Step
Phase VT Ratio	1 - 4000	1
Ground VT ratio	1 - 4000	1
Event masking (only through communications)	YES / NO	

Communications General Settings	
Setting	Range
Communications Password Enable	YES / NO
Communications Password Timeout	1 - 4000 min
Communications Password	8 characters

Note: Settings for establishing communication through the remote port. On TPI models those settings only can be modified through ZIVercom[®] communications program.

5.3 Voltage Protection Settings

Voltage Elements Protection Settings. Models TPI-A		
Setting	Range	Step
Settings for 1 and 2 unit		
Unit Type	Overvoltage Undervoltage	
Delayed		
Enable	YES / NO ⁽¹⁾	
Pickup		
Standard Model	20.00 - 140.00 V	1 V
12 Special Model	20.00 - 120.00 V	1 V
Definite time characteristic		
Standard Model	0 - 99.9s	0.1 s
11 Special Model	0 - 300s	0.1 s
Time dial	0.05 - 1.00	0.05
Instantaneous		
Enable	YES / NO ⁽¹⁾	
Pickup		
Standard Model	20.00 - 220.00 V	1 V
12 Special Model	20.00 - 120.00 V	1 V
Time delay		
Standard Model	0 - 99.9 s	0.1 s
11 Special Model	0 - 300 s	0.1 s

(1) The HMI is disabled by setting the pickup to 0 V and annulling the pickup enable in the communications program ZIVercom[®].



Voltage Elements Protection Settings. Models TPI-B		
Setting	Range	Step
Settings for 1 and 2 unit		
Unit Type	Overvoltage Undervoltage	
Delayed		
Enable	YES / NO ⁽¹⁾	
Pickup	20.00 -1 40.00 V	1 V
Definite time characteristic	0 - 99.9s	0.1 s
Time dial	0.05 - 1.00	0.05
Instantaneous		
Enable	YES / NO ⁽¹⁾	
Pickup	20.00 - 220.00 V	1 V

(1) The HMI is disabled by setting the pickup to 0 V and annulling the pickup enable in the communications program ZIVercom[®].

Voltage Elements Protection Settings. Models TPI-C		
Setting	Range	Step
Delayed		
Enable	YES / NO ⁽¹⁾	
Pickup	4.00 - 60.00 V	1 V
Definite time characteristic	0 - 99.9s	

(1) The HMI is disabled by setting the pickup to 0 V and annulling the pickup enable in the communications program ZIVercom[®].



Voltage Elements Protection Settings. Models TPI-E		
Setting	Range	Step
Phase Units. Settings for 1 and 2 unit		
Unit Type	Overvoltage Undervoltage	
Delayed		
Enable	YES / NO ⁽¹⁾	
Pickup		
Standard Model	20.00 - 140.00 V	1 V
12 Special Model	20.00 - 120.00 V	1 V
Curve Type		
Standard Model	Definite Time / Inverse	0.1 s
12 Special Model	Definite Time	
Time dial	0.05 - 1.00	0,05
Definite time characteristic	0 - 99.9 s	0.1 s
Instantaneous		
Enable	YES / NO ⁽¹⁾	
Pickup		
Standard Model	20.00 - 220.00 V	1 V
12 Special Model	20.00 - 120.00 V	1 V
Time delay	0 - 99.9 s	0.1 s
Unidad de neutro		
Unit Type	Overvoltage Undervoltage	
Enable	YES / NO ⁽¹⁾	
Pickup		
Standard Model	4 - 60 V	1 V
12 Special Model	8 - 60 V	1 V
Time delay		
Standard Model	0 - 100 s	0.1 s
12 Special Model	0 - 99.9 s	0.1 s

(1) The HMI is disabled by setting the pickup to 0 V and annulling the pickup enable in the communications program ZIVercom®.

5.4 Logic Settings

Logic Settings
The logic settings in models TPI-A, TPI-B and TPI-E are those of the voltage element masks. Either through the communication ports or the HMI, the user can mask or unmask the various units. The model TPI-C, in contrast, does not allow these settings.



5.5 Status Contact Inputs, Auxiliary Contact Outputs and LED Targets

Configuring the Status Contact Inputs, Auxiliary Contact Outputs and LED Targets

The settings of the contact inputs and outputs and of the LED targets are modified by using the program **ZIVercom**® to access the unit through the local and remote communication ports of models **TPI-A**, **TPI-B** and **TPI-C**. For model **TPI-E**, these modifications can only be made through the local port.

The auxiliary outputs can also be configured as NO or NC by internal jumpers. The location of these jumpers on the unit's motherboard and the meaning of their position are specified in figure 5.1.

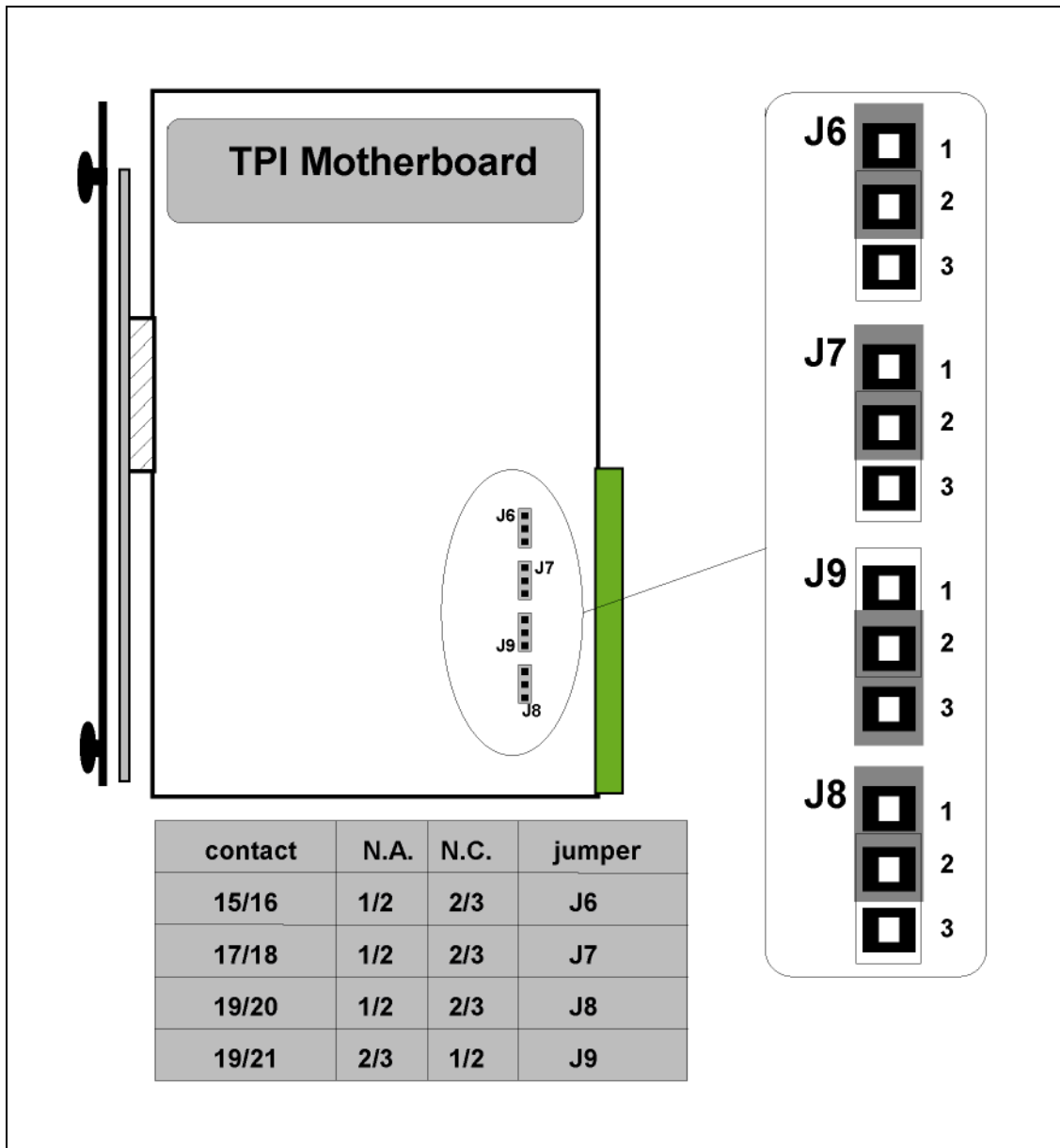

Figure 5.1: Internal Jumpers.

6. Description of Operation



6.1	Voltage Elements.....	6-2
6.1.1	Voltage Element Block Diagram.....	6-3
6.1.2	Open-Delta Voltage Element (TPI-E).....	6-3
6.1.3	Maximum-Voltage Elements.....	6-4
6.1.4	Minimum-Voltage Elements.....	6-4
6.1.5	Blocking the Elements.....	6-4
6.1.6	Voltage/Time Characteristic.....	6-5
6.2	General Settings.....	6-7
6.3	Logic (Trip Masking).....	6-7
6.4	Event Recording.....	6-8
6.5	Contacts Inputs, Outputs and LEDs.....	6-10
6.5.1	Status Contact Inputs.....	6-10
6.5.2	Auxiliary and Trip Contact Outputs.....	6-11
6.5.3	LEDs.....	6-13
6.6	Communications.....	6-14
6.6.1	Communications Settings.....	6-14
6.6.2	Communications Types.....	6-14
6.6.3	Communicating with the Unit.....	6-14



6.1 Voltage Elements

The equipment is fitted with a set of voltage elements (model will determine number and type), however the operating characteristics are the same in all cases. Each voltage element may be set up as a maximum- or minimum-voltage element (except in specific circumstances where the element is already defined -see Chapter 1). These elements are composed of a time unit and an instantaneous unit, each of which have the following settings:

- **Pickup**
- **Definite Time Delay**

In the time modules featured in the current elements, the time setting corresponds to the fixed-time selection or via an inverse curve determined by its index. One of these two options will be available, depending on the model. The pickup output, however, stays active in all cases for a minimum time of 200 ms.

In the models **TPI-A**-****12**** and **TPI-E**-****12**** the time setting in the time modules included in the voltage elements corresponds to the time dial of the fixed time curve.

Figure 6.1 shows the representative block diagram for one of the voltage elements. This diagram applies to all the elements of which equipment could be composed, although it should be remembered that the unit may lack the time element, depending on the specific model.

Associated with the voltage level-detection logic there is a setting to determine whether the unit will operate in overvoltage or undervoltage mode and a second setting for the pickup value. This means that if the unit has been defined as an overvoltage element and the measured value exceeds the setting value by a certain amount, the unit will pick up, whereas if the unit is in undervoltage mode, it will pick up if the measured value falls short of the setting value by a certain amount. Note that the overvoltage/undervoltage selection setting is not available on all models (see Chapter 5 for details of each model).

Enabling pickup also enables the time function, by applying steps to a counter, the end count of which determines the performance of the time element. When the effective value measured falls below the set pickup, the integrator is quickly reset. Enabling the output requires the pickup to be active throughout the integration time. Any resetting will return the integrator to its initial conditions, so when it is reactivated the time count will start from zero.



6.1.1 Voltage Element Block Diagram

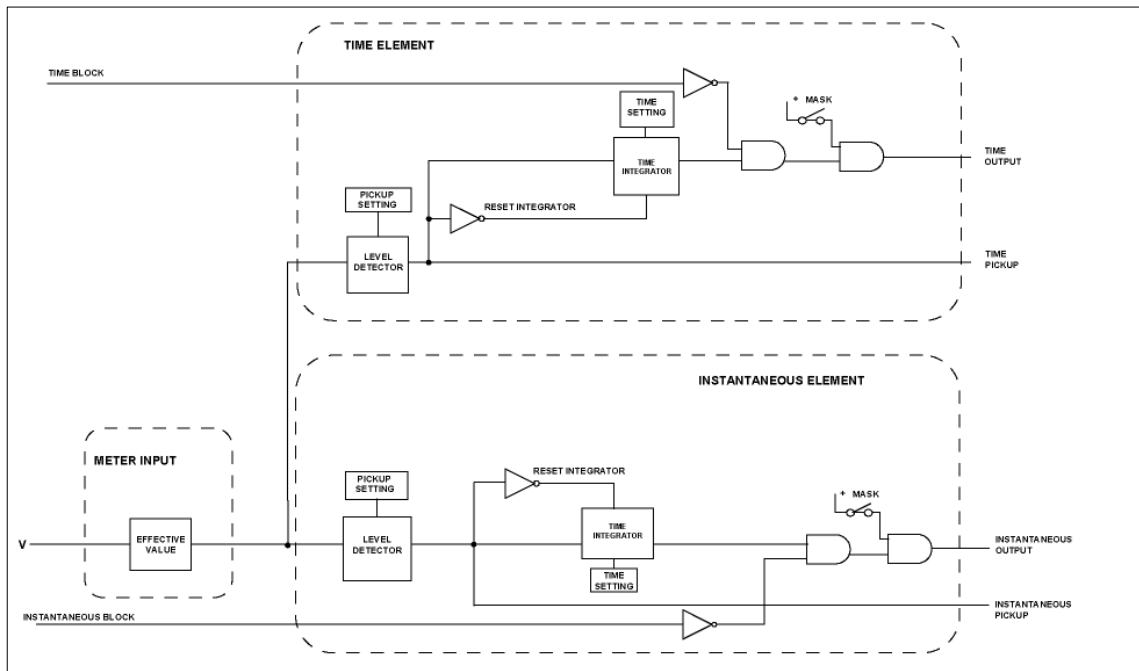

Figure 6.1: Voltage Element Block Diagram.

6.1.2 Open-Delta Voltage Element (TPI-E)

The ground element on the TPI-E model has been designed to act only as an overvoltage element. It has no associated analog input channel, but takes the voltage value from the vector sum of the three phases divided by three (this calculation is performed internally). Its pickup and reset levels are indicated in section 6.1.2.

$$U_n = \frac{V_a + V_b + V_c}{3}$$



6.1.3 Maximum-Voltage Elements

The maximum-voltage elements operate on the RMS input-voltage value. If the unit is set up as instantaneous or timed for a fixed time, pickup will occur when the value measured matches or exceeds the pickup value (100% of the setting), resetting at around 95% of the setting.

If the timing follows an inverse curve, pickup will also occur when the value measured exceeds 100% of the pickup value, resetting when the voltage returns below 95% of the fixed setting.

Certain exceptions apply to models **TPI-A**, **TPI-B** and **TPI-C**: for values of below 50V, the value between activation and resetting is 2.5 V for the **TPI-A** and **TPI-B** models. On the **TPI-C** model, for values below 15 V this value is 0.8 V. In the case of the model **TPI-A **-**** 12 **** (reduced hysteresis) the reset value should be 102% for all settings.

In the model **TPI-E**-****12**** the operation of the overvoltage elements is based on the RMS value of the voltage input. Both for the instantaneous and the time element, the activation is when the measured value matches or exceeds the pick-up value (100% of the setting) and resetting takes place when the voltage is at 99% of the setting value. In the model **TPI-A**-****12**** the pick-up of the units is also at 100% of the setting value but the reset is at 98%.

6.1.4 Minimum-Voltage Elements

The minimum-voltage elements are operated—as are the maximum-voltage elements—on the RMS input-voltage value. If the unit is set up as instantaneous or timed for a fixed time, pickup will occur when the value measured is lower than or equal to the pickup value (100% of the setting), resetting in this case when the voltage exceeds 105% of the setting.

If the timing follows an inverse curve, pickup will occur when the value measured is less than 100% of the pickup value, and will rest when the voltage exceeds 105% of the setting value.

For low voltages there is also an exception that affects the **TPI-A**, **TPI-B** and **TPI-C** models: for values below 50 V, the value between activation and resetting is 2.5 V for the **TPI-A** and **TPI-B** models. On the **TPI-C** model, for values below 15 V, this value is 0.8V. In the case of the model **TPI-A **-**** 12 **** (reduced hysteresis) the reset value should be 102% for all settings.

In the model **TPI-E**-****12**** the operation of the undervoltage elements is based on the RMS value of the voltage input. Both for the instantaneous and the time element, the operation starts when the measured value is less than or equal to the pick-up value (100% of the setting) and the resetting takes place when the voltage exceeds 101% of the setting value. In the model **TPI-A**-****12**** the pick-up of the units is also at 100% of the setting value but the reset is at 102%.

6.1.5 Blocking the Elements

The block function can be selected by programming an input for this purpose. This function prevents the corresponding element from being activated, provided that no trip has been generated previous to the block signal.



6.1.6 Voltage/Time Characteristic

Figures 6.2 and 6.3 show the Voltage-curve characteristic families available for timed overvoltage and undervoltage elements.

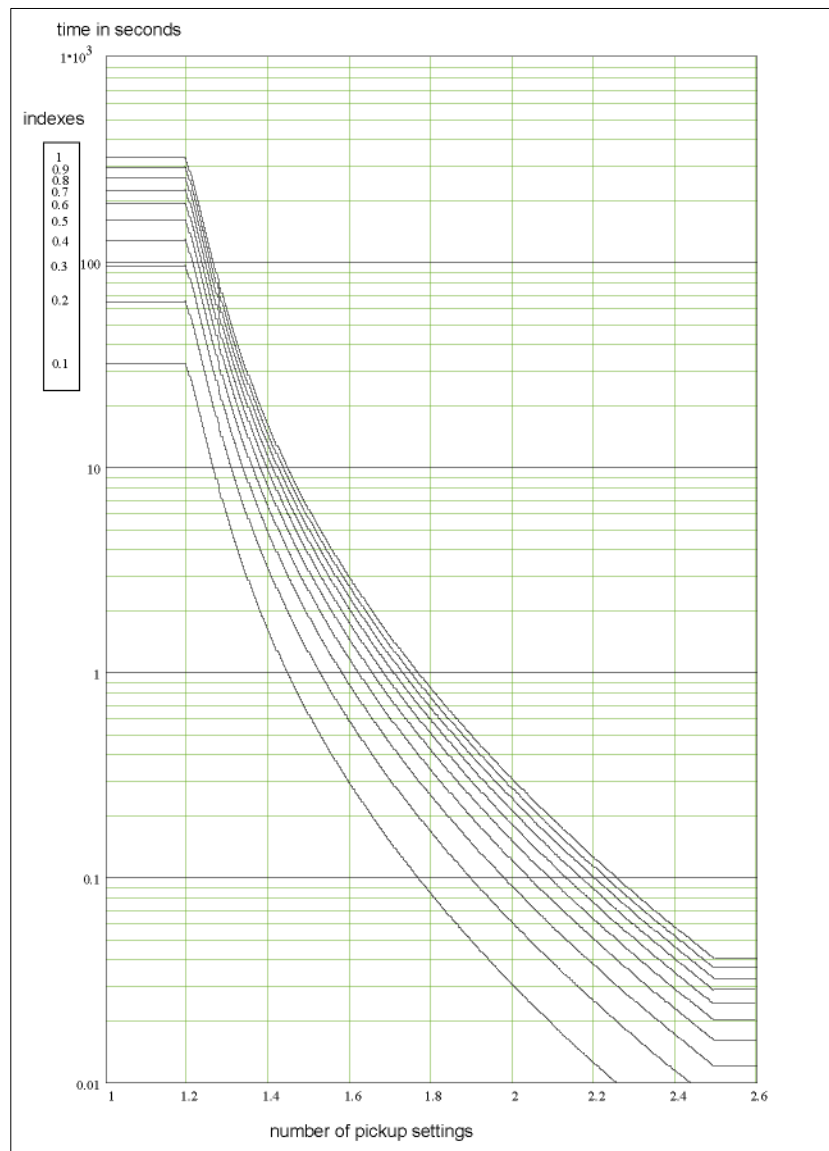

Figure 6.2: Inverse Overvoltage Curve.

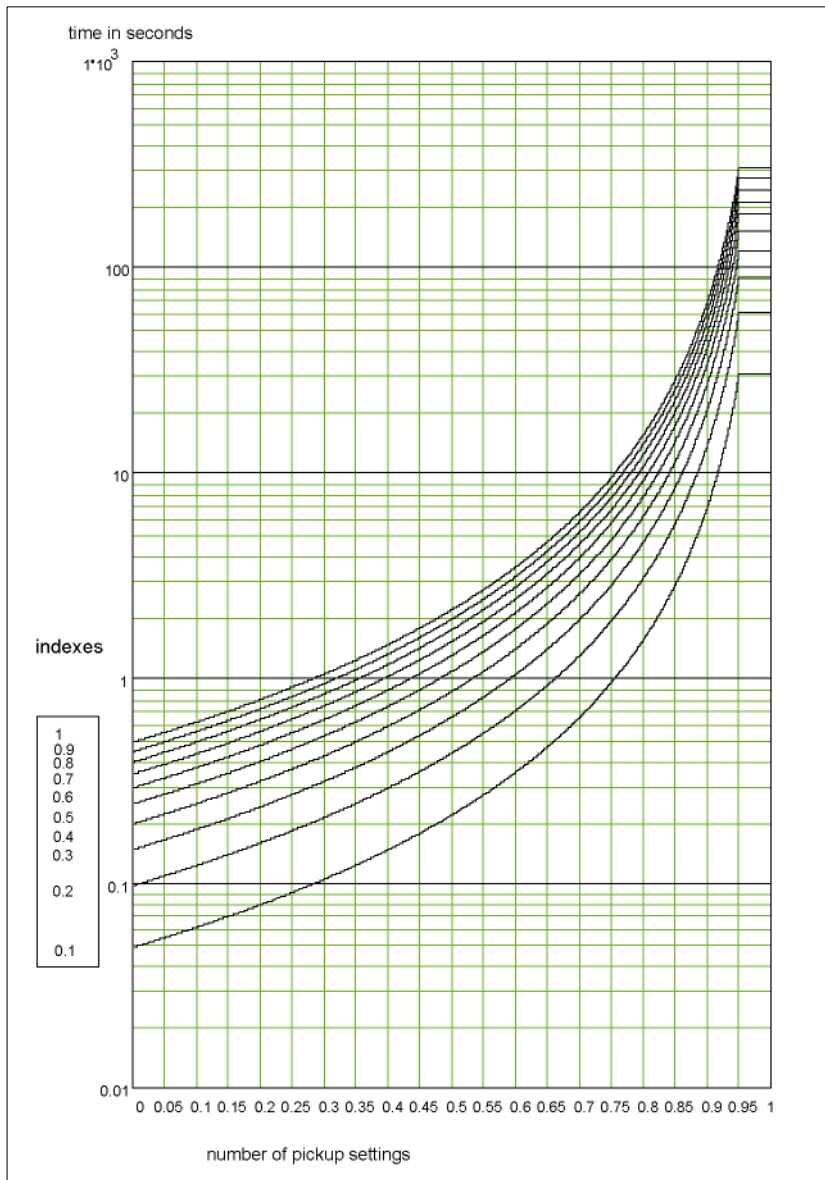

Figure 6.3: Inverse Undervoltage Curve.



6.2 General Settings

- **Transformer Ratio**

The transformer ratio settings define the way in which the analog values will be displayed on the HMI. A transformer ratio setting of 1 will display the secondary values of the CTs, whereas a setting equivalent to the CT transformation ratio will display the primary values of the system.

- **Event Masking**

It is possible to mask unneeded or unimportant events to the study of the behaviour of the unit. Event masking can be done only through communications.

6.3 Logic (Trip Masking)

A logic setting is available on all models except **TPI-C** (as indicated in Chapter 5), with the function of determining whether the voltage elements will be activated or not (depending on the units for each model). The masking of elements, which corresponds to the **NO** setting (**N** on the display, with the box **not** checked in the communications software), prevents the functioning of the unit from being processed once it has picked up and activated. In other words, the unit generates the output-activation pickup events without the trip outputs being activated.

This masking action is subordinate to whether or not the corresponding element has been enabled, since the pickup process will not be triggered if the element has been disabled.



6.4 Event Recording

Each of the functions used by the protection will record an event on the Event Recorder whenever one of the situations cited in table 6-1 occurs.

Table 6-1: Event Recording					
Record	Description	TPI-A	TPI-B	TPI-C	TPI-E
Environment Record	Cold pickup	✓	✓		✓
	Initialization following setting changes	✓	✓		✓
Voltage Protection	Time pickup phase A element 1	✓	✓		✓
	Time pickup phase B element 1		✓		✓
	Time pickup phase C element 1		✓		✓
	Time pickup ground				
	Instantaneous pickup phase A element 1	✓	✓		✓
	Instantaneous pickup phase B element 1		✓		✓
	Instantaneous pickup phase C element 1		✓		✓
	Instantaneous pickup ground				✓
	Time output phase A element 1 active	✓	✓		✓
	Time output phase B element 1 active		✓		✓
	Time output phase C element 1 active		✓		✓
	Time output ground active				
	Instantaneous output phase A element 1 active	✓	✓		✓
	Instantaneous output phase B element 1 active		✓		✓
	Instantaneous output phase C element 1 active		✓		✓
	Instantaneous output ground active				✓
	Time pickup phase A element 2	✓	✓		✓
	Time pickup phase B element 2		✓		✓
	Time pickup phase C element 2		✓		✓
	Instantaneous pickup phase A element 2	✓	✓		✓
	Instantaneous pickup phase B element 2		✓		✓
	Instantaneous pickup phase C element 2		✓		✓
	Time output phase A element 2 active	✓	✓		✓
	Time output phase B element 2 active		✓		✓
	Time output phase C element 2 active		✓		✓
	Instantaneous output phase A element 2 active	✓	✓		✓
	Instantaneous output phase B element 2 active		✓		✓
	Instantaneous output phase C element 2 active		✓		✓
	Time pickup phase A element 1 reset	✓	✓		✓
	Time pickup phase B element 1 reset		✓		✓
	Time pickup phase C element 1 reset		✓		✓
	Time pickup ground reset				✓
Instantaneous pickup phase A element 1 reset	✓	✓		✓	
Instantaneous pickup phase B element 1 reset		✓		✓	
Instantaneous pickup phase C element 1 reset		✓		✓	
Instantaneous pickup ground element 1 reset					
Time output phase A element 1 active deactivated	✓	✓		✓	
Time output phase B element 1 active deactivated		✓		✓	
Time output phase C element 1 active deactivated		✓		✓	
Time output ground active deactivated					



Table 6-1: Event Recording

Record	Description	TPI-A	TPI-B	TPI-C	TPI-E
Voltage Protection	Instantaneous output phase A element 1 deactivated	✓	✓		✓
	Instantaneous output phase B element 1 deactivated		✓		✓
	Instantaneous output phase C element 1 deactivated		✓		✓
	Instantaneous output ground deactivated				✓
	Time pickup phase A element 2 reset	✓	✓		✓
	Time pickup phase B element 2 reset		✓		✓
	Time pickup phase C element 2 reset		✓		✓
	Instantaneous pickup phase A element 2 reset	✓	✓		✓
	Instantaneous pickup phase B element 2 reset		✓		✓
	Instantaneous pickup phase C element 2 reset		✓		✓
	Time output phase A element 2 active	✓	✓		✓
	Time output phase B element 2 active		✓		✓
	Time output phase C element 2 active		✓		✓
	Instantaneous output phase A element 2 active	✓	✓		✓
	Instantaneous output phase B element 2 active		✓		✓
	Instantaneous output phase C element 2 active		✓		✓

• Event Recorder Management

The event recorder stores up to one hundred (100) events. The Event Recorder structure is a FIFO stack. Once the full capacity is reached, a new event overwrites the oldest event. The following information is provided with each event register:

- **Phase and ground voltage values (depending on model) measured at the moment the event was generated**
- **Date and time of the event**

The management of the event recorder is optimized so that simultaneous operations generated by the same event occupy a single position in the event memory. However, if the occurrences were not simultaneous, two separate events would be generated. Simultaneous events are defined as those operations separated by an interval of less than 1 ms, which is the resolution time of the recorder.

Important: Please note that the option of masking unnecessary events is available to prevent filling the recorder to capacity (100 events) and erasing important information on previous events. Events can only be masked via communications, in the main settings.

• Records Retrieval

The information provided by **ZIVercom**[®] communications and remote management software is presented in a fully decoded user-friendly format, displaying each of the inputs on the above table separately.



6.5 Contacts Inputs, Outputs and LEDs

TPI units are provided with programmable inputs and outputs enabling user configuration of flexible logic designs. The following paragraphs contain a description of the programming structure to configure protection inputs, outputs and LEDs. Factory default settings may be modified using **ZIVercom**[®] software.

6.5.1 Status Contact Inputs

The terminal unit metering elements and logic functions use the Logic Input Signals listed in Table 6-2 below. Any of these Logic Input Signals can be assigned to one of the unit's two Status Contact Inputs. It should be remembered that several different Logic Input Signals can be assigned to one Status Contact Input, but a given Logic Input Signal can only be assigned to one Status Contact Input.

Number	Name	Description	TPI-A	TPI-B	TPI-C	TPI-E
2	BDT_1N	Block time ground trip element 1			✓	
3	BDI_1N	Block instantaneous ground trip element 1				✓
4	BDT_1F	Block time phase trip element 1	✓	✓		✓
5	BDI_1F	Block instantaneous phase trip element 1	✓	✓		✓
8	BDT_2F	Block time phase trip element 2	✓	✓		✓
9	BDI_2F	Block instantaneous phase trip element 2	✓	✓		✓

Users can easily program different input settings using the communications ports (see Chapter 5 for each specific model), as required.



6.5.2 Auxiliary and Trip Contact Outputs

• Auxiliary Contact Outputs

Terminal unit metering elements and logic functions generate a series of Logic Output Signals during terminal unit operation. Each of these signals has either a “True” or “False” value and this status can be used as an input to either of the combinational logic gates whose block diagrams are shown in Figure 6.4. This output can be connected to one of the unit’s programmable physical auxiliary outputs (AUX1 and AUX2). There is also a third, non-programmable, auxiliary output (AUX3), which corresponds to a unit “in service”.

There are two gates, each with a maximum of 8 inputs. One of them is an **OR** gate (any signal activates the output) and the other an **AND** gate (all the signals must be activated to activate the output). **OR** or **AND** operations may also be performed between these two gates.

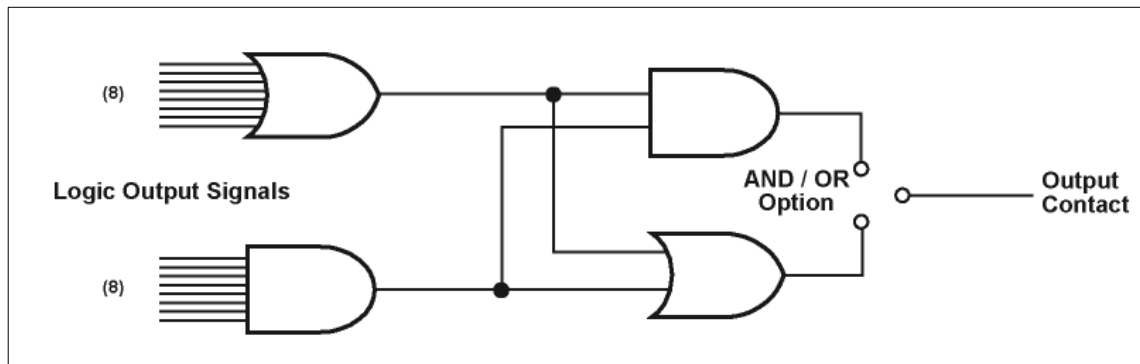

Figure 6.4: Block Diagram of the Logic Cell Associated with each of the Physical Outputs.

Table 6-3 lists the logic outputs available for each TPI model.

Table 6-3: Auxiliary Contact Outputs						
Number	Name	Description	TPI-A	TPI-B	TPI-C	TPI-E
1	ST_V_1A	Time output of element voltage 1 phase A	✓	✓		✓
2	ST_V_1B	Time output of element voltage 1 phase B		✓		✓
3	ST_V_1C	Time output of element voltage 1 phase C		✓		✓
4	ST_V_1N	Time output of element voltage 1 ground			✓	
5	SI_V_1A	Instantaneous output of element voltage 1 phase A	✓	✓		✓
6	SI_V_1B	Instantaneous output of element voltage 1 phase B		✓		✓
7	SI_V_1C	Instantaneous output of element voltage 1 phase C		✓		✓
8	SI_V_1N	Instantaneous output of element voltage 1 ground				✓
9	ST_V_2A	Time output of element voltage 2 phase A	✓	✓		✓
10	ST_V_2B	Time output of element voltage 2 phase B		✓		✓
11	ST_V_2C	Time output of element voltage 2 phase C		✓		✓



Table 6-3: Auxiliary Contact Outputs

Number	Name	Description	TPI-A	TPI-B	TPI-C	TPI-E
13	SI_V_2A	Instantaneous output of element voltage 2 phase A	✓	✓		✓
14	SI_V_2B	Instantaneous output of element voltage 2 phase B		✓		✓
15	SI_V_2C	Instantaneous output of element voltage 2 phase C		✓		✓
17	AT_V_1A	Time pickup element voltage 1 phase A	✓	✓		✓
18	AT_V_1B	Time pickup element voltage 1 phase B		✓		✓
19	AT_V_1C	Time pickup element voltage 1 phase C		✓		✓
20	AT_V_1N	Time pickup element voltage 1 ground			✓	
21	AI_V_1A	Instantaneous pickup element voltage 1 phase A	✓	✓		✓
22	AI_V_1B	Instantaneous pickup element voltage 1 phase B		✓		✓
23	AI_V_1C	Instantaneous pickup element voltage 1 phase C		✓		✓
24	AI_V_1N	Instantaneous pickup element voltage 1 ground				✓
25	AT_V_2A	Time pickup element voltage 2 phase A	✓	✓		✓
26	AT_V_2B	Time pickup element voltage 2 phase B		✓		✓
27	AT_V_2C	Time pickup element voltage 2 phase C		✓		✓
29	AI_V_2A	Instantaneous pickup element voltage 2 phase A	✓	✓		✓
30	AI_V_2B	Instantaneous pickup element voltage 2 phase B		✓		✓
31	AI_V_2C	Instantaneous pickup element voltage 2 phase C		✓		✓
32	DISP	Trip output 1 active		✓		✓
33	IN_1	Digital input IN-1 active	✓	✓	✓	✓
34	IN_2	Digital input IN-2 active	✓	✓	✓	✓
37	DISP	Trip output 1 active	✓		✓	✓
39	AUX_1	Digital output AUX-1 active				✓
40	AUX_2	Digital output AUX-2 active				✓
41	AUX_3	Digital output AUX-3 active				✓

- Trip Contact Outputs

The protection is provided with one physical manoeuvre output, a trip output, each with two contacts that are internally configurable to NO or NC. The location of these contacts and the configuration procedure are outlined in Chapter 5 of this manual.



6.5.3 LEDs

The TPI models have 8 optical indicators (LED), located on the front panel. Seven of these are configurable, while the other indicates whether the unit is "Ready". Each of the configurable LEDs is associated with a combination function (see diagram in Figure 6.5).

It works in a similar way to the auxiliary outputs, with one of the two gates having eight inputs and acting as an OR gate (any signal activates the output), while the other has a single input; OR and AND operations can also be performed between the two.

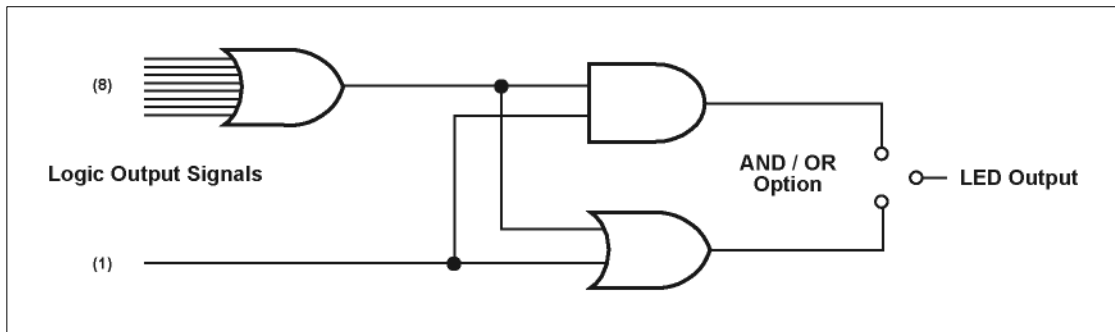

Figure 6.5: Block Diagram of the Logic Cell Associated with each of the Outputs Affecting the LEDs.

Each LED can be defined as memorized or non-memorized. If it is memorized, it will stay lit, even when the lit setting is reset. An order can be given to reset the memorized LEDs via the keypad (see Chapter 7, Keypad and Alphanumeric Display).

It is important to note that the signals that control the LEDs are memorized via a volatile memory, so any loss of power will mean that this information will be lost.

The LEDs may be associated with any of the logical outputs available (see Table 6-3), plus those listed in Table 6-4 below, which apply exclusively to the LEDs:

Table 6-4: LEDs						
Number	Name	Description	TPI-A	TPI-B	TPI-C	TPI-E
39	AAUX1	Digital output AUX-1 active	✓	✓	✓	
40	AAUX2	Digital output AUX-2 active	✓	✓	✓	
41	AAUX3	Digital output AUX-3 active	✓	✓	✓	



6.6 Communications

6.6.1 Communications Settings

Communications settings are listed in Chapter 5 (Settings) and include the unit number, baud rate, stop bits, and parity.

6.6.2 Communications Types

TPI terminals have two communications ports: an RS232C fixed port on the front panel, and another optional port at the rear, which can be glass fiber optics, 1-mm plastic fiber optics, RS232C or RS495. Technical data relative to these ports is given in Chapter 2 (Technical Data).

6.6.3 Communicating with the Unit

Communications via these ports are achieved using the **ZIVercom**[®], communications software, which enables dialog with the **TPI** family of units and other equipment, either **locally** (via PC connected to the front port) or **remotely** (via the real serial port), to cover any programming, setting, record or report needs, etc.

These communications ports can only be configured via the MMI. It is important to note that the same setting applies to the local and remote ports on the **TPI-A**, **TPI-B** and **TPI-C** models, while on the **TPI-E** model only the remote port can be configured, since the local-port settings are fixed at 4.800 bauds, 1 stop bit and even parity (see Chapter 5).

On the **TPI-A**, **TPI-B** and **TPI-C** models the same controller is used for the local and remote ports, which means that communications cannot be set up through both ports at once. The **TPI-E** model, however, has two controllers (one for each port), so communications can be set up via both ports at once.

The communications software which covers the models in question, **ZIVercom**[®], is a user-friendly, Windows[™] based software tool that is password-protected to provide access only to authorized personnel. The software allows easy navigation of and access to available settings and actions through a series of intuitive menus and graphical user interfaces.

The following information on the status of the unit that can be accessed in both local and remote modes:

- Metering Display
- Settings
- Inputs
- Outputs/LEDs
- Event Records

7. Alphanumeric Keypad and Display



7.1	Alphanumeric Display and Keypad.....	7-2
7.2	Keys, Functions and Operation Modes.....	7-3
7.3	Screens Sequence Using a Single Key	7-4
7.4	Display Sequence Using the Complete Keypad	7-6



7.1 Alphanumeric Display and Keypad

The *display* is 7x5-point dot matrix with four characters. It provides information on terminal unit alarms, settings, metering, status, etc. The default display is the model identification (#TPI) as shown in figure 7.1.



Figure 7.1: Alphanumeric Display.

The **TPI** keypad consists of 3 keys (see figure 7.2). This keypad is associated with the information on the alphanumeric display. Only one key is accessible (the ↓ key) when the cover is installed on the equipment ↓.

Starting from the default display, there are two modes for operating the keypad: with a single key or with all three keys.

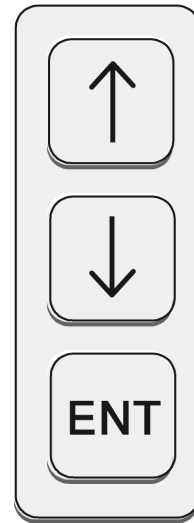

Figure 7.2: Keypad.



7.2 Keys, Functions and Operation Modes

- **Option Selection**

By using the selection keys (↑↓), it is possible to scroll through the various options on the display. The **ENT** key is used to confirm a selection.

To scroll through various settings, use the ↓ key. Once the desired setting is found, use the **ENT** to select it. The setting value will be displayed. If a setting needs to be changed, press the **ENT** key a second time and the setting value will blink.

- **Change of Settings (Range)**

In model **TPI-E**, for settings with a numeric value (inside a range), the procedure is as follows: The first digit in the setting will blink. Pressing the ↑ key, it is possible to scroll through the various values for that character. Once the selection is found, press the ↓ key to set it, and the next digit will blink. Repeat the procedure until the setting is completed. For digits where no changes are desired, press the ↓ key to skip to the next digit. Once every digit has been set, press the **ENT** key to set the value and the display will show the setting identifier. Proceed to the next setting by pressing the ↓ key.

For the rest of the models, when the first digit of a value is blinking, the ↓ and ↑ keys are used to find the desired value, which is selected by pressing **ENT**. This makes the next digit blink and so on until completing the setting, which is set by pressing **ENT** on the last digit.

The system does not allow exceeding the range for a given setting. When setting a value out of range, the value resets to zero and the blinking cursor is placed on the first digit, meaning that the setting change must start over.

- **Change of Settings (Options)**

For settings with preset options, it is possible to scroll through the various values using the ↑ and ↓ keys. Once the selection is displayed, press the **ENT** key to set the value and the display will show the setting identifier. Proceed to the next setting by pressing the ↓ key.

- **Exit Menus or Settings**

After an operation has been performed (selection, confirmation, change of settings, viewing of information, etc.) return to the previous level in the menu by pressing the ↑ key.



7.3 Screens Sequence Using a Single Key

From the default screen, the following data screens can be sequentially displayed by pressing the down arrow key ↓:

- Metering of each voltage unit at the time of viewing
- Event type and element that has tripped
- Date and time of the trip
- Reset trip information
- Reset LEDs

Figure 7.3 represents the display sequence with the general data of the last trip. The numbers and the form of the second sequence (metering and event type that caused the trip) vary depending on the TPI model. The shaded areas depict displays common to all the models.

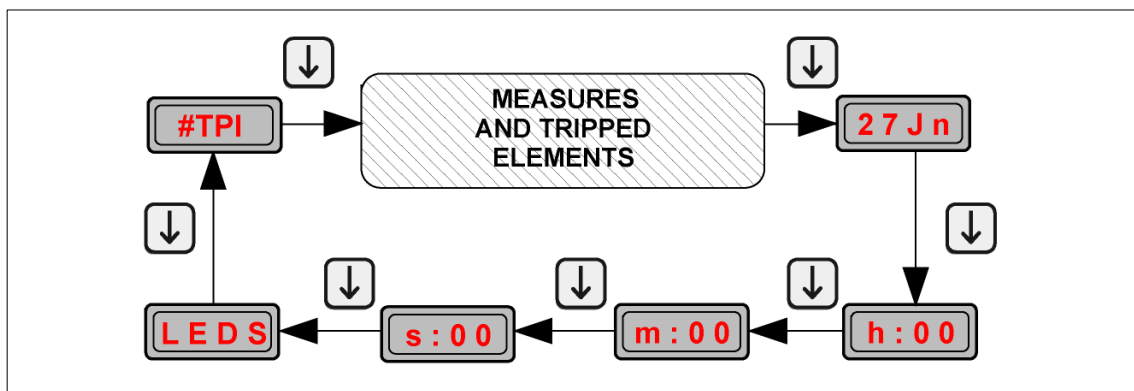

Figure 7.3: Display Sequence with the ↓ Key.

The display mnemonics are:

27 J n Indicates the date (day and month) of the last event. The month is represented with two letters. If there has been no trip, the date will be the current one.

h:00 Indicates the hour of the last trip. If there has been no trip, the hour indicated is 00.

m:00 Indicates the minute in which the last trip occurred. If there has been no trip, the minute indicated is 00.

s:00 Indicates the second at which the last trip occurred. If there has been no trip, the second indicated is 00.

RST? Trip indication reset. Once the trip conditions have been removed, the trip indication can be reset by holding down the ↓ key for more than two (2) seconds. Pressing the ↓ key as usual will skip to the next display.

LEDs From this display, the LEDs can be reset by holding down the ↓ key for more than two seconds. Pressing the ↓ key as usual (less than two seconds) returns to the default display.



The displays indicating voltage metering and the event type that has caused the trip, diagrammed in figure 7.3, are now described with the specifics for each model.

• Model TPI-A

A 1 2 5 Indicates the voltage measured by the phase A unit or voltage $\emptyset A-\emptyset B$ in real time. In this case, overvoltage unit 1, phase A, measures a voltage of 125 V.

1 A > Indicates the event type that has caused the trip: 1A, element tripped (that of overvoltage of unit 1, phase A); > trip type: delayed.

• Model TPI-B

A 1 2 5 Indicates the voltage measured by the phase A unit or voltage $\emptyset A-\emptyset B$ in real time. In this case, overvoltage unit 1, phase A, measures a voltage of 125 V.

B 1 2 5 Indicates the voltage measured by the phase B unit or voltage $\emptyset B-\emptyset C$ in real time. In this case, overvoltage unit 1, phase B, measures a voltage of 125 V.

C 1 2 5 Indicates the voltage measured by the phase C unit or voltage $\emptyset C-\emptyset A$ in real time. In this case, the unit measures a voltage of 125V.

1 A > Indicates the event type that has caused the trip: 1A, element tripped (that of overvoltage of unit 1, phase A); > trip type: delayed.

• Model TPI-C

N 0 2 5 Indicates the voltage measured by the ground unit in real time. In this case, the residual overvoltage unit, (**N**), measures a voltage of 25 V.

1 N > Indicates the event type that has caused the trip. **1N** element tripped (in this case, there is only one element, the ground unit); > trip type: delayed.

• Model TPI-E

A 1 2 5 Indicates the voltage measured by the phase A element or voltage $\emptyset A-\emptyset B$ in real time. In this case, the overvoltage unit 1, phase A, measures a voltage of 125V.

B 1 2 5 Indicates the voltage measured by the phase B element or voltage $\emptyset B-\emptyset C$ in real time. In this case, overvoltage unit 1, phase B, measures a voltage of 125 V.

C 1 2 5 Indicates the voltage measured by the phase C element or voltage $\emptyset C-\emptyset A$ in real time. In this case, the overvoltage unit 1, phase C, measures a voltage of 125V.

N 0 2 5 Indicates the voltage measured by the ground unit in real time. In this case, the residual overvoltage unit, (**N**), measures a voltage of 25 V.

N > > Indicates the event type that has caused the trip. **N** refers to the unit tripped: the ground unit; > > refers to the trip type: in this case, instantaneous.



7.4 Display Sequence Using the Complete Keypad

From the default display, there is a looped series of display sequences. By using the selection keys (↑ and ↓) and the ENT key, the following options can be accessed.

- **Settings**
 - general
 - protection
 - logic
- **Information**
 - contact input status
 - contact output status
 - frequency
 - protection elements status
- **Configuration**
 - communications
 - language
 - frequency (according to model)

For a global display of the screen sequence and the keys used to move forward in the sequence, below is a table describing the process.

- **General Settings: HMI Access**

SETT	GENR	R TT	0000
INFO	PROT		
CONF	LOGI		

- **Protection Settings: HMI Access**

SETT	GENR	U1
INFO	PROT	U1<
CONF	LOGI	CURV
		DIAL
		TEMP
		U1<<
		TEMP
		UN>>
		TEMP
		U2
		U2<
		CURV
		DIAL
		TEMP
		U2<<
		TEMP
		UN>>
		TEMP



- **Logic Settings: HMI Access**

SETT	GENR	MASK
INFO	PROT	
CONF	LOGI	

- **Information Menu: HMI Access**

SETT	INPT
INFO	OUPT
CONF	FREQ
	PICK

- **Communications Configuration: HMI Access**

SETT	COMN	EQ_N
INFO	LANG	BAUD
CONF	FREQ	STOP
		PARI
		MODB

- **Language Configuration: HMI Access**

SETT	COMN	ENGL
INFO	LANG	POR
CONF	FREQ	SPA



8. Receiving Tests



8.1	General	8-2
8.1.1	Accuracy	8-2
8.2	Preliminary Inspection	8-3
8.3	Insulation Test.....	8-3
8.4	Voltage Measuring Test.....	8-4
8.5	Overvoltage/Undervoltage Units Test.....	8-5
8.6	Operating Time Test	8-6
8.7	Contact Inputs, Auxiliary Outputs, and LED Targets Test.....	8-7
8.8	Communications Test	8-8
8.9	Installation.....	8-8
8.9.1	Location	8-8
8.9.2	Connection.....	8-8



8.1 General

Improper handling of electrical equipment is extremely dangerous. Damage to equipment and injury to personnel can result when proper safety precautions are not followed. Therefore, only skilled and qualified personnel familiar with appropriate safety procedures and precautions should work with this equipment. The following general safety precautions are provided as a reminder:

- High magnitude voltages are present in auxiliary supply and measuring circuits even after equipment has been disconnected.
- Equipment should be solidly grounded before handling or operating.
- Under no circumstances should the operating limits of the equipment be exceeded (auxiliary voltage, current, etc.).
- The supply voltage should be disconnected from the unit before extracting or inserting any module; otherwise damage may result.

The number, the type and the specific characteristics of the acceptance tests for the various models are listed in the following table.

TPI	Preliminary Inspection
	Insulation Test
	Voltage Measuring Test
	Operating Time Test
	Voltage Elements Test (TPI-A, TPI-B and TPI-E)
	Status Contact Inputs, Outputs and LED Targets Test
	Communications Test

8.1.1 Accuracy

The results obtained in electrical testing greatly depend on the accuracy of the measuring instruments and test source signals (auxiliary voltage, and measurement voltages). Therefore, verification of the information specified in the Technical Data section of this manual can only reasonably be achieved using test equipment under normal reference conditions and with the tolerances indicated in the **UNE 21-136** and **IEC 255** standards, in addition to using precision instruments.

It is extremely important that there be no distortion (<2%) in the test source signals as harmonics can affect internal measuring of the equipment. For example, distortions will affect this unit, made up of non-linear elements, differently from an AC ammeter, because the measurement is made differently in both cases

It must be emphasized that the accuracy of the test will depend on the instruments used for measuring as well as the source signals used. Therefore, tests performed with secondary equipment should focus on operation verification and not on measuring accuracy.



8.2 Preliminary Inspection

The following aspects of the unit should be examined:

- The unit is in good mechanical condition, all parts are securely attached and no assembly screws are missing.
- The unit model numbers coincide with those specified in the order.

8.3 Insulation Test

While testing for insulation of switchgear and external wiring, it is recommended that the terminal unit be disconnected to avoid damage if the test is not performed properly or if there are shorts in the harness, since insulation testing has been performed on 100 % of the units by the manufacturer. The following paragraphs describe common mode and transverse mode insulation tests:

• Common Mode

Wire all the terminals of the unit together except number 30, number 10 and all those that already have a wire connected (connections between external units and internal drivers), and apply 2000 VAC, during 1min between this set of terminals and the metal case.

• Transverse Mode

Divide the terminals into groups according to the model of the unit and apply 2000 VAC during 1 min between each pair of groups in the table:

Table 8-1: Terminals Groups		
TPI-A	TPI-B/E	TPI-C
1-2	1-2	1-2
---	3-4	---
---	5-6	---
11-12-13-14	11-12-13-14	11-12-13-14
15-16-17-18	15-16-17-18	15-16-17-18
19-20-21-22-23-24-25-26-27	19-20-21-22-23-24-25-26-27	19-20-21-22-23-24-25-26-27
28-29	28-29	28-29

Note: there are internal capacitors that can generate high voltage if the test points for the insulation test are removed without first reducing the test voltage.



8.4 Voltage Measuring Test

To avoid trips while performing this test, protection elements must be disabled beforehand. Then apply the voltage indicated in table 8-2 for the model to be tested to each of the voltage channels. For models **TPI-A** and **TPI-C**, the voltages are applied between terminals 1 and 2. For models **TPI-B** and **TPI-E**, apply the voltages to each of the three phases: between terminals 1 and 2 for phase A, between terminals 3 and 4 for phase B and between terminals 5 and 6 for phase C. Afterwards, check in the metering display that the values of the voltage of these elements are within the range of values indicated in table 8-2.

Table 8-2: Voltage Measuring Test		
Models TPI-A, TPI-B and TPI-E		
Voltage Applied	Measured Value	Value in display (see Note)
100 Vac	95 - 105 Vac	95 - 105 Vac
200 Vac	190 - 210 Vac	189 - 210 Vac
Models TPI-C		
Voltage Applied	Measured Value	Value in display
25 Vac	23 - 27 Vac	22 - 27 Vac
60 Vac	57 - 63 Vac	56 - 64 Vac
Special Models TPI-***_****12**		
Voltage Applied	Measured Value	Value in display
50 Vac	49 - 51 Vac	49 - 51 Vac
100 Vac	97 - 103 Vac	97 - 103 Vac
120 Vac	118 - 123 Vac	118 - 123 Vac

Note: In model TPI-E, this is the value for the phases. If the test is performed phase by phase, the value measured in the display for ground must be 1/3 of that indicated in the table.



8.5 Overvoltage/Undervoltage Units Test

The overvoltage/undervoltage units test should be performed unit by unit, disabling those that are not being tested at any given time.

Pickup and Reset

Set the desired pickup values for the relevant unit and check its enabling or reset by means of the pickup flags from the Information - Pickup menu and the auxiliary contact output programmed for this purpose.

The pickup and reset margins are those specified in table 8-3.

Table 8-3: Pickup and Reset Values						
	Overvoltage			Undervoltage		
	pickup	reset	tolerance	pickup	reset	tolerance
TPI-A / TPI-B	100%	95% (-2.5V)	5%	100%	105% (+2.5V)	5%
TPI-C	100%	95% (-0.8V)	5%	100%	105% (+0.8V)	5%
TPI-E	100%	95%	5%	100%	105%	5%
TPI-A**_****12**	100%	99%	1%	100%	101%	1%
TPI-A**-****12**	100%	98%	1%	100%	102%	1%

Note: TPI A and TPI-B for values below 50 V. TPI C for values below 15 V.

Table of terminal numbers:

Table 8-4: Terminals Groups		
Models TPI-A and TPI-C	Models TPI-B and TPI-E	
1-2	1-2, 3-4, 5-6	voltage input
15-16	15-16	trip
17-18	17-18	trip
19-20-21	19-20-21	(NO or NC) output 1
22-23-24	22-23-24	output 2
25-26-27	25-26-27	in service



8.6 Operating Time Test

Operating times can be verified monitoring the trip outputs (terminals 15-16 or 17-18).

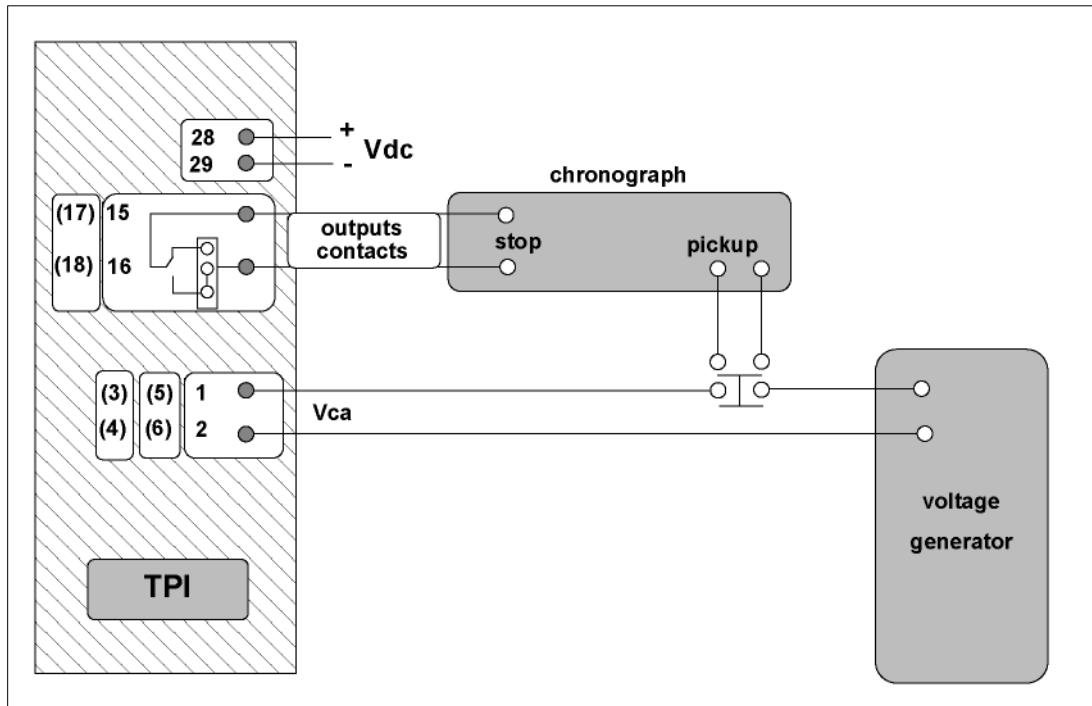

Figure 8.1: Operating Time Test Setup.

- **Fixed Time or Instantaneous**

If the unit is set as maximum voltage, apply 5 % more than the setting selected for pickup. Operating time should be the selected time setting $\pm 5 \%$ or 25 ms (whichever is greater).

If the unit is set as minimum voltage, apply 5% less than the setting selected for pickup. Operating time should be the selected time setting $\pm 5 \%$ or 25 ms (whichever is greater).

For maximum as well as minimum voltage, it must be borne in mind that the 0-ms setting will have an operating time of approximately 30 ms.

- **Inverse Time**

For a given curve, operation time depends on the time dial setting and the applied voltage (number of times of the set pickup value). Tolerance is $\pm 5 \%$ of the current value.



8.7 Contact Inputs, Auxiliary Outputs, and LED Targets Test

Connect the unit to a suitable power supply (rated Vdc) for the model. Ready LED will illuminate.

- **LEDs**

Keep pressing the ↓ key until the word LEDs appears in the display. Hold it down until all the LEDs are lit. Release the key and check that all the LEDs go off.

- **Contact Inputs**

Apply the rated voltage between terminals 11-12 and 13-14 with the negative on terminals 12 and 14. Position the *display* on contact inputs from the information menu (see Chapter 7 Alphanumeric display, section 7.4.2 Information displays) and check that contact inputs are ON. Remove the voltage and check that the contact inputs are OFF.

- **Contact Outputs**

Trip terminals 15-16 and 17-18 are tested in the operating times test.

To test the auxiliary contact outputs (AUX-1 and AUX-2), provoke their operation according to how they are configured. Should they not be configured, both contact outputs can be configured for the test as follows:

AUX 1 Enabling contact input 1

AUX 2 Enabling contact input 2

At the same time that the contact inputs are tested, verify that terminals 19-20; 19-21 and 22-23; 22-24 change state when contact inputs IN 1 and IN 2 respectively are energized.

Check the auxiliary output contact “In Service” (AUX 3) by making the verifications in the following table:

contact 25-26	contact 25-27	
open	close	energized
close	open	not energized



8.8 Communications Test

Connect the unit to a suitable power supply (rated Vdc) for the model. The **Ready** LED will illuminate.

Use the keypad to set communications to 4,800 bauds in the communications configuration menu. (See Chapter 7, Alphanumeric display, section 7.4.3 Configuration).

Connect to the terminal unit through the local communications port using a male DB9 (9-pin) serial connection wire. Synchronize time using the **ZIVercom**® software program. Disconnect the communications wire and disconnect the terminal unit power supply and wait for two minutes. Afterwards, connect the power supply and connect to the terminal unit through the remote communications port. Activate the cyclical mode in the **ZIVercom**® software program and verify that the time updates properly.

8.9 Installation

8.9.1 Location

The location where the terminal unit is to be installed should meet the following minimum conditions to ensure correct operation, long service life, and ease of installation and maintenance. These minimum conditions are the following:

- Absence of dust
- Absence of vibration
- Easy access
- Absence of humidity
- Adequate lighting
- Vertical or horizontal mounting

Mounting should be in accordance with the drawings.

8.9.2 Connection

Annex B contains a diagram of the unit's external connections. Terminal 30, housing ground, and terminal 10, if the model has one, must be grounded so that the disturbance-filtering circuits can function. The wire used for grounding these terminals should be stranded 2.5 mm². Ground wire length should be minimized and not exceed 12".

A. DNP 3.0 Communications Protocol



A.1	Physical Architecture	A-2
A.2	Settings	A-3
A.3	Description of Operation	A-3
A.3.1	DNP 3.0 Protocol	A-3
A.3.2	Communications	A-4
A.4	Alphanumeric Keypad and Display	A-4
A.4.1	DNP 3.0 Settings Menu (<i>ZIVercom</i> [®])	A-4



Model-specific documentation with DNP 3.0 communications PROTOCOLO

A.1 Physical Architecture

Figures A.1 and A.2 shows de options for the TPI models.

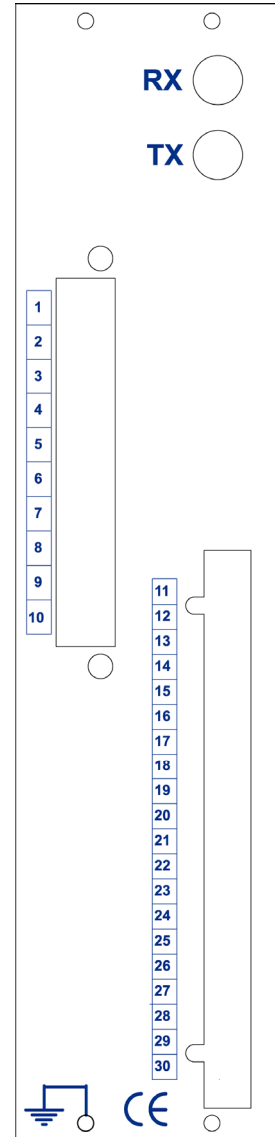

Figure A.1: 3TPI Rear View.

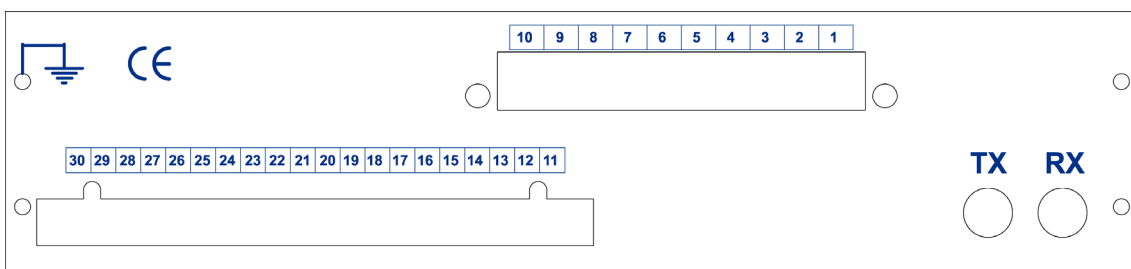

Figure A.2: 8TPI Rear View.



A.2 Settings

DNP 3.0 Protocol Configuration Settings		
Setting	Range	Step
MTU Address (Master equipment number)	0-65534	1
RTU Address (Slave equipment number)	0-65534	1
Unsolicited Report	0-1	
Timeout N7	50-65535 ms.	1 ms.
N7 Retry Counter	0-3	1
Pre-transmission Time	0-65535 ms.	1 ms.
Echo Control Enable	0-1	

Metering Changes Settings		
Setting	Range	Step
Settings independents for metering changes from 0 to 5		
% Change Metering	0.00-100 %	0.01%

A.3 Description of Operation

A.3.1 DNP 3.0 Protocol

The models with the option DNP 3.0 communication protocol present the following configuration settings:

- **DNP Configuration Settings**

The DNP 3.0 protocol configuration settings incorporate the definition of the **RTU** and **MTU** address (number of slave equipment and number of master equipment); the activation or deactivation of **unsolicited**, the setting of **Reply Timeout N7**, which fixes the time out to receive confirmation from the master asked by the slave with CON bit set to 1, the number of **new attempts** which can be applied when waiting for confirmation from the master, if it does not arrive repeatedly within the time fixed by the **Timeout N7**, the setting for the **warning time setting**, time which generates the number of warning characters, and the one of **echo control**, i. e. the activation or deactivation of the transmission echo.

Note: warning time and echo control settings are used to have various equipments connected to a concentrator type 4CCY and working in multi-master mode.

- **Metering Changes (Deadband Values)**

Analog metering bands (according to equipment and model) can be set. The setting represents the percentage over the maximum value of the measure, that will be taken as reference to test if there is an analogical change to record. In other word, a change will be recorded if the difference in the analogical measures is greater than the set percentage.

If it is adjusted to 100%, analogical changes in this measure will not be recorded, which is then understood as being in a deactivated state.



A.3.2 Communications

- **Communication with the Equipment**

The TPI models have a frontal and a rear communications port.

A.4 Alphanumeric Keypad and Display

The settings of the communications protocol DNP3 are not adjustable locally from the relay itself. They can only be changed by using the communications program **ZIVercom**®.

A.4.1 DNP 3.0 Settings Menu (ZIVercom®)

Configuración DNP 3.0

Configuración DNP 3.0

Número MTU: 666
 Número RTU: 2
 Timeout N7: 6000 ms
 Nº intentos N7: 3

Hab Mensajes No Solicit Ctrl ECO Tempo de pre-transmisión: 0 ms

Bandas muertas

Med. 0: 10.00% Med. 1: 20.00% Med. 2: 30.00%
 Med. 3: 100.00% Med. 4: 100.00% Med. 5: 100.00%

Recoger Enviar Salir

B. Schemes and Drawings



Dimension and Drill Hole Schemes

3TPI	>>4BF0100/0016
Adapter board to 19"x 2U / 8TPI	>>4BF0100/0026

External Connection Schemes

TPI-A	>>3RX0133/0035 (generic)
TPI -B/E	>>3RX0133/0032 (generic)
TPI -C	>>3RX0133/0038 (generic)

CAJA TIPO "D"
ENCLOSURE TYPE "D"
CAIXA TIPO "D"

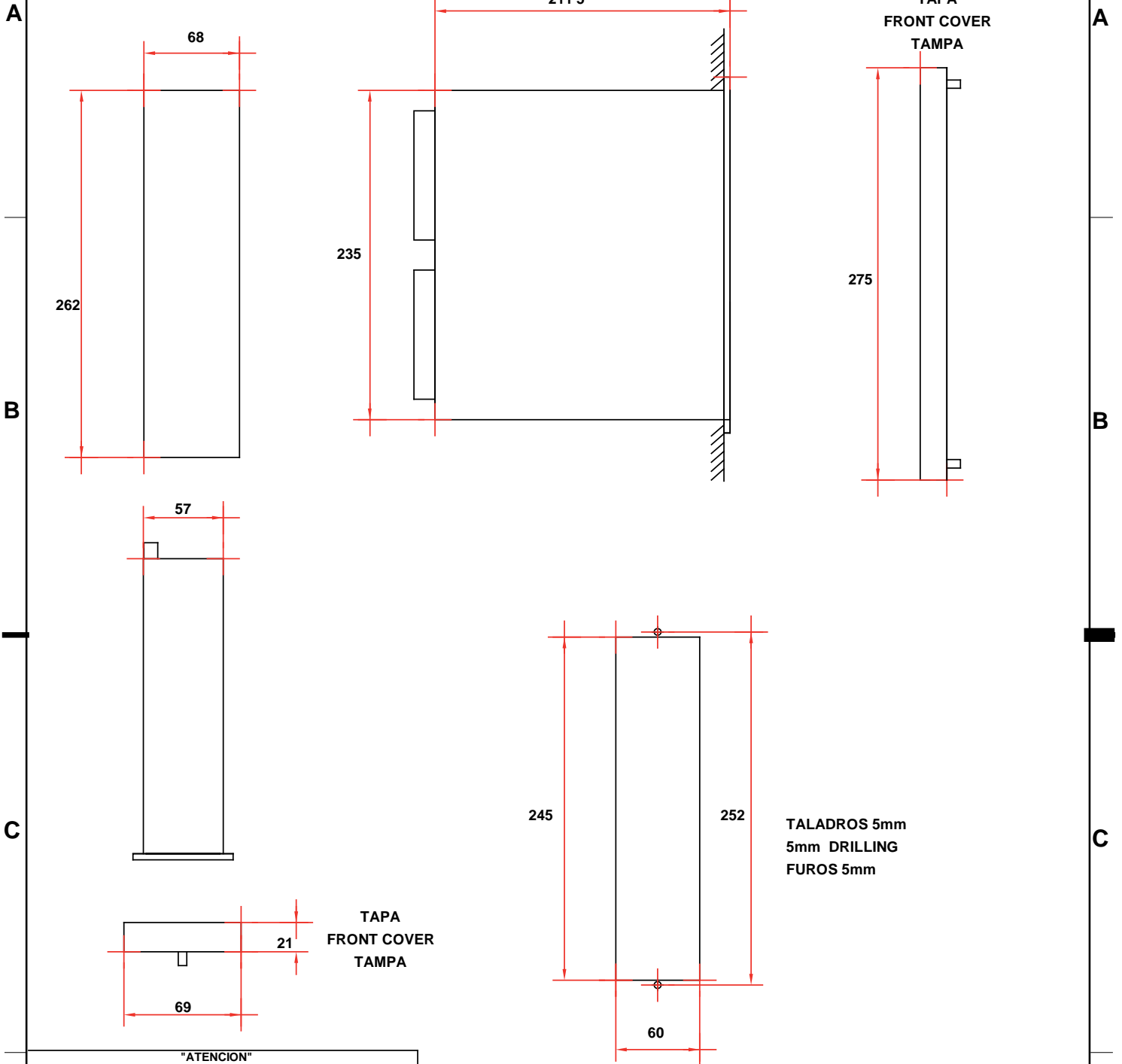

"ATENCIÓN"
Este documento contiene información confidencial propiedad de ZIV. Cualquier forma de reproducción o divulgación está absolutamente prohibida y puede ser causa de severas medidas legales.

"ATENÇÃO"
Este documento contém informação confidencial de propriedade de ZIV. Qualquer forma de reprodução ou divulgação está absolutamente proibida e sujeita a severas medidas legais.

"WARNING"
This document contains trade secret information of ZIV. Unauthorized disclosure is strictly prohibited and may result in serious legal consequences.

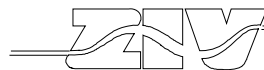

ZIV Aplicaciones y Tecnología, S.L.

TÍTULO: DIMENSIONES Y TALADRADO

PROYECTO: CAJA TIPO "D" 6U 1/7RACK

Rev. 0
Rev. 1 14/9/98
Rev. 2 14/2/02

NÚMERO: 4BF0100/0016

REVISIONES	0	CDN9605104	1	CDR9809104
2	CD0202125	3	4	
5		6	7	
8		9	10	
11		12	13	
14		15	16	

	Fecha	Nombre	Hoja: 1
Dibujado	3/5/96	J.C.S.	Continua en Hoja:
Aprobado	3/5/96	R.O.	

1

2

3

4

A

A

B

B

C

C

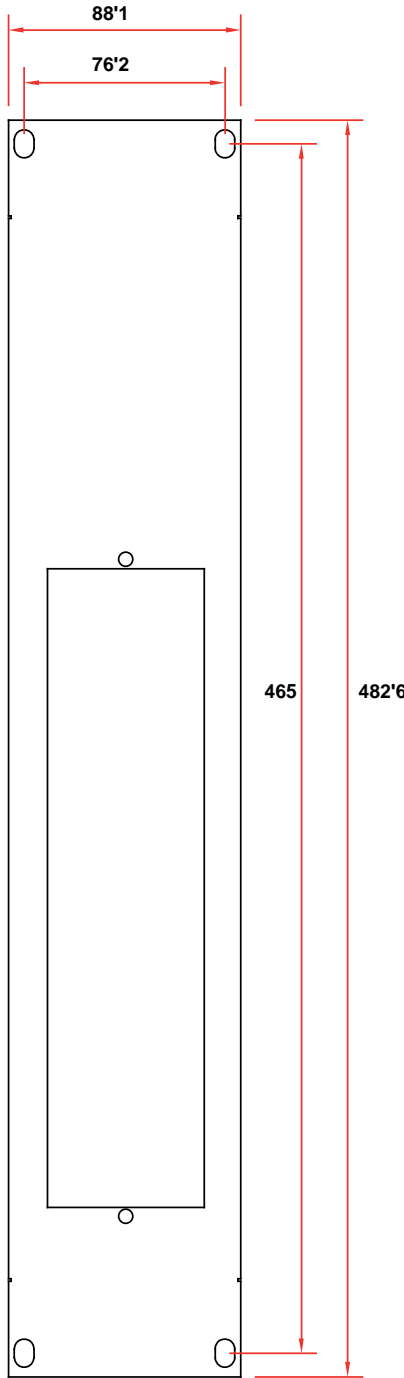

"ATENCIÓN"

Este documento contiene información confidencial propiedad de ZIV. Cualquier forma de reproducción o divulgación está absolutamente prohibida y puede ser causa de severas medidas legales.

"ATENÇÃO"

Este documento contém informação confidencial de propriedade de ZIV. Qualquer forma de reprodução ou divulgação está absolutamente proibida e sujeita a severas medidas legais.

"WARNING"

This document contains trade secret information of ZIV. Unauthorized disclosure is strictly prohibited and may result in serious legal consequences.

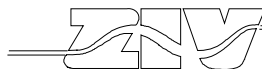

ZIV Aplicaciones y Tecnología, S.L.

TÍTULO: PLACA ADAPTACION A 19`` X 2U

PROYECTO: RELE INDUSTRIAL

Rev. 0
Rev. 14/2/02

NÚMERO: 4BF0100/0026

REVISIONES	0	CDN9904147	1	CD0202125
2	3		4	
5	6		7	
8	9		10	
11	12		13	
14	15		16	

	Fecha	Nombre	Hoja: 1
Dibujado	29/4/99	J.C.S.	Continua en Hoja:
Aprobado	29/4/99	R.O.	

1

2

3

4

D

D

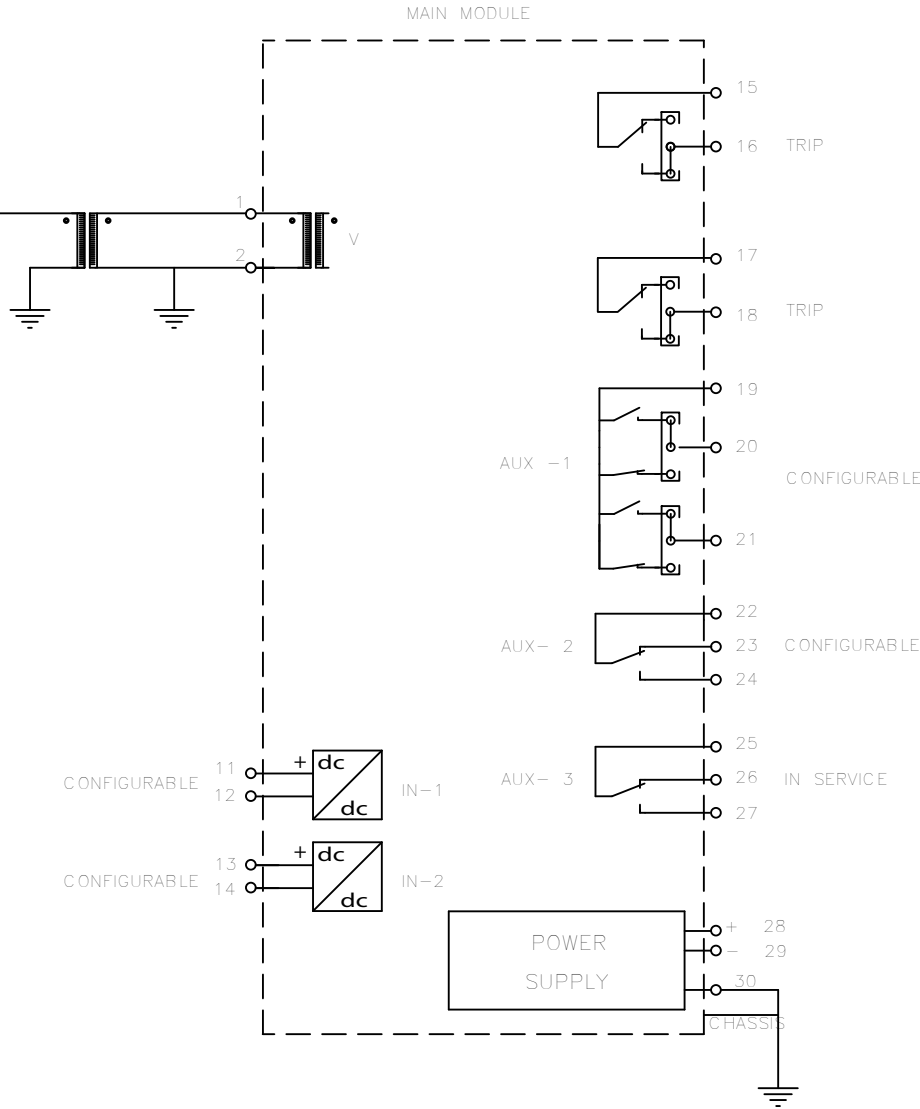
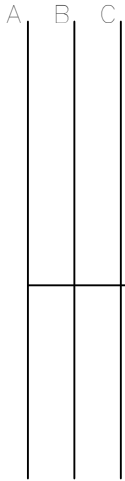
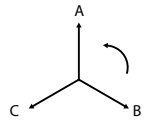

- LEDS
- 1.-CONFIGURABLE.
 - 2.-CONFIGURABLE.
 - 3.-CONFIGURABLE.
 - 4.-CONFIGURABLE.
 - 5.-CONFIGURABLE.
 - 6.-CONFIGURABLE.
 - 7.-CONFIGURABLE.



ZIV Aplicaciones y Tecnología S.L.

TITLE> EXTERNAL CONNECTIONS 3/8TPI-A

PROJECT> VOLTAGE PROTECTION

Rev 0 NUMBER> 3RX0133/0035

Drawn	Date	Name	Sheet:1
Approved	29/07/04	J.C.S.	Continued on Sheed:
	29/07/04	P.A.	

"WARNING"
This document contains trade secret information of Z I V.
Unauthorized disclosure is strictly prohibited and may result
in serious legal consequences.

REVISIONS	0	CD0407162	1	2	3	4
5	6	7	8	9	10	
11	12	13	14	15	16	

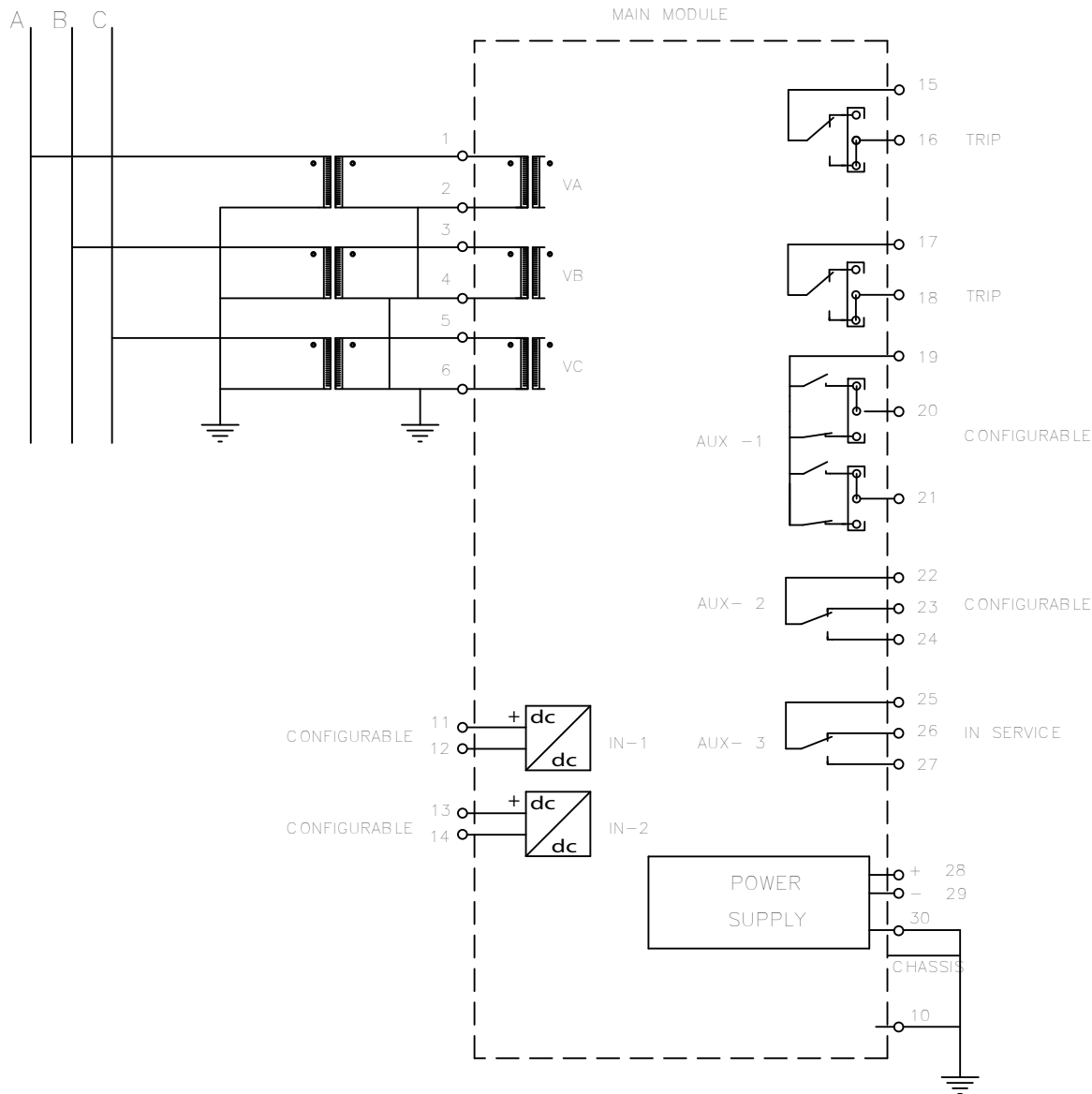
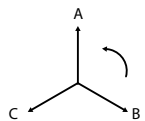

LEDS

- 1.- CONFIGURABLE.
- 2.- CONFIGURABLE.
- 3.- CONFIGURABLE.
- 4.- CONFIGURABLE.
- 5.- CONFIGURABLE.
- 6.- CONFIGURABLE.
- 7.- CONFIGURABLE.



ZIV Aplicaciones y Tecnología S.L.

TITLE> EXTERNAL CONNECTIONS #TPI-B/E

PROJECT> VOLTAGE PROTECTION

Rev 0 NUMBER> 3RX0133/0032

Drawn	Date	Name	Sheet:1
Approved	01/08/03	J.C.S.	Continued on Sheed:
	01/08/03	J.M.Y.	

"WARNING"

This document contains trade secret information of Z I V.
Unauthorized disclosure is strictly prohibited and may result
in serious legal consequences.

REVISIONS	0	1	2	3	4
5	6	7	8	9	10
11	12	13	14	15	16

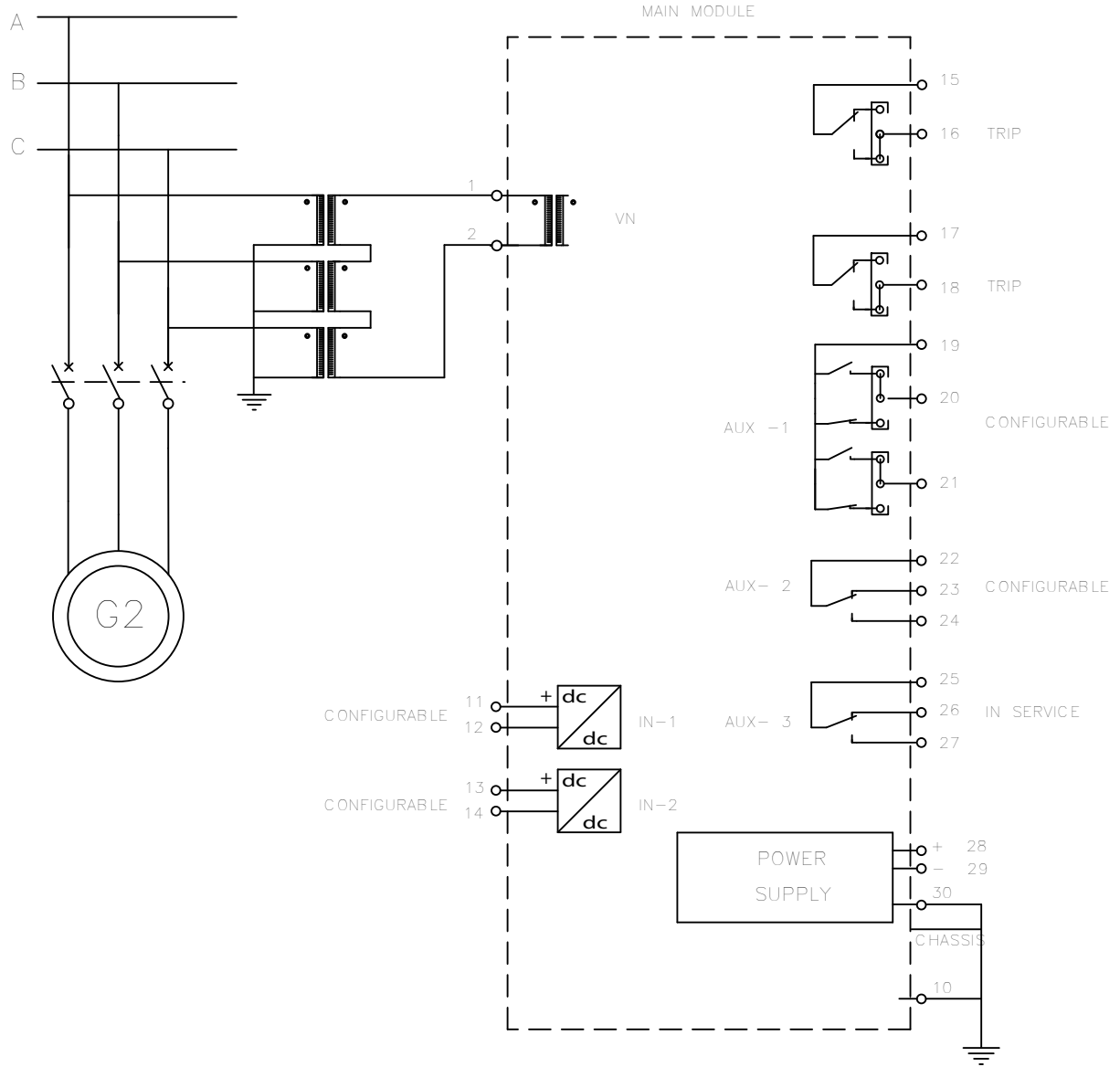
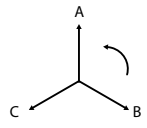

LEDS

- 1.- CONFIGURABLE.
- 2.- CONFIGURABLE.
- 3.- CONFIGURABLE.
- 4.- CONFIGURABLE.
- 5.- CONFIGURABLE.
- 6.- CONFIGURABLE.
- 7.- CONFIGURABLE.

"WARNING"
This document contains trade secret information of Z I V.
Unauthorized disclosure is strictly prohibited and may result
in serious legal consequences.

REVISIONS	0	1	2	3	4
5	6	7	8	9	10
11	12	13	14	15	16

ZIV Aplicaciones y Tecnología S.L.

TITLE> EXTERNAL CONNECTIONS #TPI-C

PROJECT> VOLTAGE PROTECTION

Rev 0

NUMBER> 3RX0133/0038

	Date	Name	Sheet:1
Drawn	24/05/07	J.C.S.	Continued on Sheed:
Approved	24/05/07	P.A.	

C. List of Illustrations and Tables



C.1	List of figures.....	C-2
C.2	List of tables.....	C-2



C.1 List of figures

4.	Physical Architecture	
4.1	3TPI Front View	4-2
4.2	8TPI Front View	4-2
4.3	8TPI Rear View	4-3
4.4	3TPI Rear View	4-4
5.	Settings	
5.1	Internal Jumpers	5-6
6.	Description of Operation	
6.1	Voltage Element Block Diagram	6-3
6.2	Inverse Overvoltage Curve	6-5
6.3	Inverse Undervoltage Curve	6-6
6.4	Block Diagram of the Logic Cell Associated with each of the Physical Outputs	6-11
6.5	Block Diagram of the Logic Cell Associated with each of the Outputs Affecting the LEDs.....	6-13
7.	Alphanumeric Keypad and Display	
7.1	Alphanumeric Display	7-2
7.2	Keypad	7-2
7.3	Display Sequence with the ↓ Key	7-4
8.	Receiving Tests	
8.1	Operating Time Test Setup.....	8-6

C.2 List of tables

6.	Description of Operation	
6-1	Status Contact Inputs.....	6-8
6-2	Auxiliary Contact Outputs	6-10
6-3	LEDs	6-11
6-4	Event Recording	6-13
8.	Receiving Tests	
8-1	Terminals Groups	8-3
8-2	Voltage Measuring Test	8-4
8-3	Pickup and Reset Values.....	8-5
8-4	Terminals Groups	8-5
8-5	Contact Outputs	8-7

D. Warranty





ZIV GRID AUTOMATION, S.L. Standard Product Warranty

All new products sold to customers are warranted against defects in design, materials, and workmanship for a period of ten (10) years from the time of delivery (at the moment the product leaves ZIV GRID AUTOMATION premises, as indicated in the shipping documents). Customer is responsible of notifying ZIV GRID AUTOMATION of any faulty conditions as soon as they are detected. If it is determined that the new product defect is covered by the warranty, ZIV GRID AUTOMATION will repair, or substitute the product at its own discretion to the customer at no charge.

ZIV GRID AUTOMATION may, at its own discretion, require the customer to ship the unit back to the factory for diagnosis before making a determination as to whether it is covered by this warranty. Shipping costs to the ZIV GRID AUTOMATION factory (including but not limited to, freight, insurance, customs fees and taxes, and any other expenses) will be the responsibility of the customer. All expenses related to the shipment of the repaired or replacement units back to the customer will be borne by ZIV GRID AUTOMATION.

Customers are responsible for all expenses related to the shipment of defective units back to ZIV GRID AUTOMATION when it is determined that such units are not covered under this warranty or that the fault is not ZIV GRID AUTOMATION's responsibility. Units repaired by ZIV GRID AUTOMATION are warranted against defects in materials, and manufacturing for a period of one (1) year from the time of delivery (at the moment the product leaves ZIV GRID AUTOMATION premises, as indicated by the shipping documents), or for the remaining of the original warranty, whichever is greater.

ZIV GRID AUTOMATION warranty does not cover: 1) improper installation, connection, operation, maintenance, and/or storage, 2) minor defects not interfering with the operation of the product, possible indemnities, misuse or improper usage, 3) abnormal or unusual operating conditions or application outside the specifications for the product, 4) application in any way different from that for which the products were designed, 5) repairs or alterations performed by individuals other than ZIV GRID AUTOMATION employees or an authorised representative.

Limitations:

- 1) Equipment or products provided but not manufactured by ZIV GRID AUTOMATION. Such products may be covered by a warranty issued by the corresponding manufacturer.
- 2) Software: ZIV GRID AUTOMATION warrants that the licensed Software corresponds with the specifications included in the instruction manuals provided with the units, or with the specifications agreed with the end-customer. ZIV GRID AUTOMATION sole and entire liability, and customer exclusive remedy, with respect to any claims relating to the Software shall be to provide a new set of diskettes free of charge.
- 3) In the case that a bank guarantee or similar instrument be required to back up the warranty period, such warranty period, and only for these purposes, will be of a maximum of twelve (12) months from the time of delivery (at the moment the product leaves ZIV GRID AUTOMATION premises, as indicated in the shipping documents).

THIS WARRANTY IS IN LIEU OF ANY OTHER WARRANTIES AND ZIV GRID AUTOMATION HEREBY DISCLAIMS ANY OTHER WARRANTY, EXPRESS OR IMPLIED, INCLUDING, WITHOUT LIMITATION, ANY WARRANTY OF MERCHANTABILITY OR FITNESS FOR A PARTICULAR PURPOSE. IN NO EVENT SHALL ZIV GRID AUTOMATION BE LIABLE FOR ANY INDIRECT, INCIDENTAL, CONSEQUENTIAL, OR SPECIAL DAMAGES OR FOR ANY OTHER LOSS, INJURY, DAMAGE, OR EXPENSE OF ANY KIND INCLUDING LOST PROFITS OR ANY OTHER PECUNIARY LOSS ARISING FROM ANY SOURCE.

ZIV GRID AUTOMATION, S.L.
Parque Tecnológico, 210
48170 Zamudio - Bizkaia - Spain
Tel.- (+34)-(94) 452.20.03
Fax - (+34)-(94) 452.21.40